



Weld Control Selector Guide

Product:	Weld Control Selector Guide
Manual:	091-0458
Revision:	Oct 2003 Rev E



The Most Comprehensive Guide to Connecting Prince® XL Spool Guns & Cobramatic® Wire Feed Systems to Welding Power Supplies

SAFETY CONSIDERATIONS

ELECTRIC ARC WELDING EQUIPMENT

CAUTION : READ BEFORE ATTEMPTING INSTALLATION, OPERATION OR MAINTENANCE OF THIS EQUIPMENT

1-1 INTRODUCTION

This equipment is intended for ultimate application by commercial/industrial users and for operation by persons trained and experienced in the use and maintenance of welding equipment. Operation should not be undertaken without adequate training in the use of such equipment. Training is available from many public and private schools or similar facilities.

Safe practices in the installation, operation and maintenance of this equipment requires proper training in the art, a careful study of the information provided with the equipment, and the use of common sense. Rules for safe use are generally provided by suppliers of welding power sources, compressed gas suppliers, and electrode suppliers. Careful compliance with these rules will promote safe use of this equipment.

The following Safety Rules cover some of the more generally found situations. READ THEM CAREFULLY. In case of any doubt, obtain qualified help before proceeding.

1-2 GENERAL PRECAUTIONS

A. Burn Prevention

ELECTRIC ARC WELDING PRODUCES HIGH INTENSITY HEAT AND ULTRAVIOLET RADIANT ENERGY WHICH MAY CAUSE SERIOUS AND PERMANENT EYE DAMAGE AND WHICH MAY DAMAGE ANY EXPOSED SKIN AREAS.

Wear helmet with safety goggles or glasses with side shields underneath, appropriate filter lenses or plates (protected by clear cover glass). This is a must for welding or cutting (and chipping) to protect the eyes from radiant energy and flying metal. Replace cover glass when broken, pitted, or spattered.

Medical first aid and eye treatment. First aid facilities and a qualified first aid person should be available for each shift unless medical facilities are close by for immediate treatment of flash burns of the eyes and skin burns.

Wear protective clothing - leather (or asbestos) gauntlet gloves, hat, and high safety-toe shoes. Button shirt collar and pocket flaps, and wear cuffless trousers to avoid entry of sparks and slag.

Avoid oily or greasy clothing. A spark may ignite them.

Flammable hair preparations should not be used by persons intending to weld or cut.

Hot metal such as electrode stubs and work pieces should never be handled without gloves.

Ear plugs should be worn when working on overhead or in a confined space. A hard hat should be worn when others work overhead.

B. Toxic Fume Prevention

WARNING: The use of this product may result in exposure to chemicals known to the State of California to cause cancer and birth defects or other reproductive harm.

Adequate ventilation. Severe discomfort, illness or death can result from fumes, vapors, heat, or oxygen enrichment or depletion that welding (or cutting) may produce. Prevent them with adequate ventilation. NEVER ventilate with oxygen.

Lead-, cadmium-, zinc-, mercury-, beryllium-bearing and similar materials, when welded or cut, may produce harmful concentrations of toxic fumes. Adequate local exhaust ventilation must be used, or each person in the area, as well as the operator, must wear an air-supplied respirator. For beryllium, both must be used.

Metals coated with or containing materials that emit toxic fumes should not be heated unless coating is removed from the work surface, the area is well ventilated, or the operator wears an air-supplied respirator.

Work in a confined space only while it is being ventilated and, if necessary, while wearing an air-supplied respirator.

Gas leaks in a confined space should be avoided. Leaked gas in large quantities can change oxygen concentration dangerously. Do not bring gas cylinders into a confined space.

Leaving confined space, shut OFF gas supply at source to prevent possible accumulation of gases in the space if downstream valves have been accidentally opened or left open. Check to be sure that the space is safe before reentering it.

Vapors from chlorinated solvents can be decomposed by the heat of the arc (or flame) to form PHOSGENE, a highly toxic gas, and other lung and eye irritating products. The ultraviolet (radiant) energy of the arc can also decompose trichloroethylene and perchloroethylene vapors to form phosgene. DO NOT WELD or cut where solvent vapors can be drawn into the welding or cutting atmosphere or where the radiant energy can penetrate to atmospheres containing even minute amounts of trichloroethylene or perchloroethylene.

C. Fire and Explosion Prevention

Causes of fire and explosion are: combustibles reached by the arc, flame, flying sparks, hot slag, or heated material, misuse of compressed gases and cylinders, and short circuits.

BE AWARE THAT flying sparks or falling slag can pass through cracks, along pipes, through windows or doors, and through wall or floor openings, out of sight of the goggled operator. Sparks can fly many feet.

To prevent fires and explosion:

Keep equipment clean and operable, free of oil, grease, and (in electrical parts) of metallic particles that can cause short circuits.

If combustibles are in area, do NOT weld or cut. Move the work if practicable, to an area free of combustibles. Avoid paint spray rooms, dip tanks, storage areas, ventilators. If the work cannot be moved, move combustibles at least 35 feet away, out of reach of sparks and heat; or protect against ignition with suitable and snug-fitting, fire-resistant covers or shields.

Walls touching combustibles on opposite sides should not be welded on (or cut). Walls, ceilings, and floor near work should be protected by heat-resistant covers or shields.

Fire watcher must be standing by with suitable fire extinguishing equipment during and for some time after welding or cutting if:

1. Appreciable combustibles (including building construction) are within 35 feet.
2. Appreciable combustibles are further than 35 feet, but can be ignited by sparks.
3. Openings (concealed or visible) in floors or walls within 35 feet may expose combustibles to sparks.
4. Combustibles adjacent to walls, ceilings, roofs, or metal partitions can be ignited by radiant or conducted heat.

Hot work permit should be obtained before operation to ensure supervisor's approval that adequate precautions have been taken.

After work is done, check that area is free of sparks, glowing embers, and flames.

An empty container that held combustibles, or that can produce flammable or toxic vapors when heated, must never be welded on or cut, unless container has first been cleaned in accordance with industry standards.

This includes: a thorough steam or caustic cleaning (or a solvent of water washing, depending on the combustible's solubility), followed by purging and inerting with nitrogen or carbon dioxide, and using protective equipment.

Water-filling just below working level may substitute for inerting.

SAFETY CONSIDERATIONS

- Continued -

A container with unknown contents should be cleaned (see paragraph above). Do NOT depend on sense of smell or sight to determine if it is safe to weld or cut.

Hollow castings or containers must be vented before welding or cutting. They can explode.

Explosive atmospheres. NEVER weld or cut where the air may contain flammable dust, gas, or liquid vapors (such as gasoline).

D. Compressed Gas Equipment

The safe handling of compressed gas equipment is detailed in numerous industry publications. The following general rules cover many of the most common situations.

1. Pressure Regulators

Regulator relief valve is designed to protect only the regulator from overpressure; it is not intended to protect any downstream equipment. Provide such protection with one or more relief devices.

Never connect a regulator to a cylinder containing gas other than that for which the regulator was designed.

Remove faulty regulator from service immediately for repair (first close cylinder valve). The following symptoms indicate a faulty regulator:

Leaks - if gas leaks externally.

Excessive Creep - if delivery pressure continues to rise with downstream valve closed.

Faulty Gauge - if gauge pointer does not move off stop pin when pressurized, nor returns to stop pin after pressure release.

Repair. Do NOT attempt repair. Send faulty regulators for repair to manufacturer's designated repair center, where special techniques and tools are used by trained personnel.

2. Cylinders

Cylinders must be handled carefully to prevent leaks and damage to their walls, valves, or safety devices:

Avoid electrical circuit contact with cylinders including third rails, electrical wires, or welding circuits. They can produce short circuit arcs that may lead to a serious accident. (See 1-3C)

ICC or DOT marking must be on each cylinder. It is an assurance of safety when the cylinder is properly handled.

Identifying gas content. Use only cylinders with name of gas marked on them; do not rely on color to identify gas content. Notify supplier if unmarked. NEVER DEFACE or alter name, number, or other markings on a cylinder. It is illegal and hazardous.

Empties: Keep valves closed, replace caps securely; mark MT; keep them separate from FULLS, and return promptly.

Prohibited use. Never use a cylinder or its contents for other than its intended use, NEVER as a support or roller.

Locate or secure cylinders so they cannot be knocked over.

Passageways and work areas. Keep cylinders clear of areas where they may be stuck.

Transporting cylinders. With a crane, use a secure support such as a platform or cradle. Do NOT lift cylinders off the ground by their valves or caps, or by chains, slings, or magnets.

Do NOT expose cylinders to excessive heat, sparks, slag, and flame, etc. that may cause rupture. Do not allow contents to exceed 55 degrees C (130 degrees F.) Cool with water spray where such exposure exists.

Protect cylinders, particularly valves from bumps, falls, falling objects, and weather. Replace caps securely when moving cylinders.

Stuck valve. Do NOT use a hammer or wrench to open a cylinder valve that cannot be opened by hand. Notify your supplier.

Mixing gases. NEVER try to mix any gases in a cylinder.

NEVER refill any cylinder.

Cylinder fittings should never be modified or exchanged.

3. Hose

Prohibited use. Never use hose other than that designed for the specified gas. A general hose identification rule is: red for fuel gas, green for oxygen, and black for inert gases.

Use ferrules or clamps designed for the hose (not ordinary wire or other substitute) as a binding to connect hoses to fittings.

No copper tubing splices. Use only standard brass fittings to splice hose.

Avoid long runs to prevent kinks and abuse. Suspend hose off ground to keep it from being run over, stepped on, or otherwise damaged.

Coil excess hose to prevent kinks and tangles.

Protect hose from damage by sharp edges, and by sparks, slag, and open flame.

Examine hose regularly for leaks, wear, and loose connections. Immerse pressured hose in water; bubbles indicate leaks

Repair leaky or worn hose by cutting area out and splicing. Do NOT use tape.

4. Proper Connections

Clean cylinder valve outlet of impurities that may clog orifices and damage seats before connecting regulator. Except for hydrogen, crack valve momentarily, pointing outlet away from people and sources of ignition. Wipe with a clean, lintless cloth.

Match regulator to cylinder. Before connecting, check that the regulator label and cylinder marking agree, and that the regulator inlet and

cylinder outlet match. NEVER Connect a regulator designed for a particular gas or gases to a cylinder containing any other gas.

Tighten connections. When assembling threaded connections, clean and smooth seats where necessary. Tighten. If connection leaks, disassemble, clean, and retighten, using properly fitting wrench.

Adapters. Use a CGA adapter (available from your supplier) between cylinder and regulator, if one is required. Use two wrenches to tighten adapter marked RIGHT and LEFT HAND threads.

Regulator outlet (or hose) connections may be identified by right hand threads for oxygen and left hand threads (with grooved hex on nut or shank) for fuel gas.

5. Pressurizing Steps:

Drain regulator of residual gas through suitable vent before opening cylinder (or manifold valve) by turning adjusting screw in (clockwise). Draining prevents excessive compression heat at high pressure seat by allowing seat to open on pressurization. Leave adjusting screw engaged slightly on single-stage regulators.

Stand to side of regulator while opening cylinder valve.

Open cylinder valve slowly so that regulator pressure increases slowly. When gauge is pressurized (gauge reaches regulator maximum) leave cylinder valve in following position: for oxygen and inert gases, open fully to seal stem against possible leak; for fuel gas, open to less than one turn to permit quick emergency shut-off.

Use pressure charts (available from your supplier) for safe and efficient recommended pressure settings on regulators.

Check for leaks on first pressurization and regularly thereafter. Brush with soap solution. Bubbles indicate leaks. Clean off soapy water after test; dried soap is combustible.

E. User Responsibilities

Follow all Safety Rules.

Remove leaky or defective equipment from service immediately for repair. Read and follow user manual instructions.

F. Leaving Equipment Unattended

Close gas supply at source and drain gas.

G. Rope Staging-Support

Rope staging-support should not be used for welding or cutting operation; rope may burn.

1-3 ARC WELDING

Comply with precautions in 1-1, 1-2, and this section. Arc Welding, properly done, is a safe process, but a careless operator invites trouble. The equipment carries high currents at significant voltages. The arc is

SAFETY CONSIDERATIONS

- Continued -

very bright and hot. Sparks fly, fumes rise, ultraviolet and infrared energy radiates, weldments are hot, and compressed gases may be used. The wise operator avoids unnecessary risks and protects himself and others from accidents.

A. Burn Protection

Comply with precautions in 1-2.

The welding arc is intense and visibly bright. Its radiation can damage eyes, penetrate lightweight clothing, reflect from light-colored surfaces, and burn the skin and eyes. Skin burns resemble acute sunburn; those from gas-shielded arcs are more severe and painful. **DON'T GET BURNED; COMPLY WITH PRECAUTIONS.**

1. Protective Clothing

Wear long-sleeve clothing in addition to gloves, hat, and shoes. As necessary, use additional protective clothing such as leather jacket or sleeves, flameproof apron, and fire-resistant leggings. Avoid outer garments of untreated cotton.

Bare skin protection. Wear dark, substantial clothing. Button collar to protect chest and neck, and button pockets to prevent entry of sparks.

2. Eye and Head Protection

Protect eyes from exposure to arc. Eyes may be damaged by radiant energy when exposed to the electric arc, even when not looking in the direction of the arc. Never look at an electric arc without protection.

Welding helmet or shield containing a filter plate shade no. 12 or denser must be used when welding. Place over face before striking arc.

Protect filter plate with a clear cover plate.

Cracked or broken helmet or shield should NOT be worn; radiation can be passed through to cause burns.

Cracked, broken, or loose filter plates must be replaced IMMEDIATELY. Replace clear cover plate when broken, pitted, or spattered.

Flash goggles with side shields MUST be worn under the helmet to give some protection to the eyes should the helmet not be lowered over the face before an arc is struck. Looking at an arc momentarily with unprotected eyes (particularly a high intensity gas-shielded arc) can cause a retinal burn that may leave a permanent dark area in the field of vision.

3. Protection of Nearby Personnel

Enclose the welding area. For production welding, a separate room or enclosed bay is best. In open areas, surround the operation with low-reflective, noncombustible screens or panels. Allow for free air circulation, particularly at floor level.

Viewing the weld. Provide face shields for all persons who will be looking directly at the weld.

Others working in area. See that all persons are wearing flash goggles.

Before starting to weld, make sure that screen flaps or bay doors are closed.

B. Toxic Fume Prevention

Comply with precautions in 1-2B.

Generator engine exhaust must be vented to the outside air. Carbon monoxide can kill.

C. Fire and Explosion Prevention

Comply with precautions in 1-2C.

Equipment's rated capacity. Do not overload arc welding equipment. It may overheat cables and cause a fire.

Loose cable connections may overheat or flash and cause a fire.

Never strike an arc on a cylinder or other pressure vessel. It creates a brittle area that can cause a violent rupture or lead to such a rupture later under rough handling.

D. Compressed Gas Equipment

Comply with precautions in 1-2D.

E. Shock Prevention

Exposed electrically hot conductors or other bare metal in the welding circuit, or in ungrounded, electrically-HOT equipment can fatally shock a person whose body becomes a conductor. **DO NOT STAND, SIT, LIE, LEAN ON, OR TOUCH** a wet surface when welding without suitable protection.

To protect against shock:

Keep body and clothing dry. Never work in damp area without adequate insulation against electrical shock. Stay on a dry duckboard, or rubber mat when dampness or sweat cannot be avoided. Sweat, sea water, or moisture between body and an electrically HOT part - or grounded metal - reduces the body surface electrical resistance, enabling dangerous and possibly lethal currents to flow through the body.

1. Grounding the Equipment

When installing, connect the frames of each unit such as welding power source, control, work table, and water circulator to the building ground. Conductors must be adequate to carry ground currents safely. Equipment made electrically HOT by stray currents may shock, possibly fatally. Do NOT GROUND to electrical conduit, or to a pipe carrying ANY gas or a flammable liquid such as oil or fuel.

Three-phase connection. Check phase requirement of equipment before installing. If only three-phase power is available, connect single-phase equipment to only two wires of the three-phase line. Do NOT connect the equipment ground lead to the third (live) wire, or the equipment will become electrically HOT - a dangerous condition that can shock, possibly fatally.

Before welding, check ground for continuity. Be sure conductors are touching bare metal of equipment frames at connections.

If a line cord with a ground lead is provided with the equipment for connection to a switch box, connect the ground lead to the grounded switch box. If a three-prong plug is added for connection to a grounded mating receptacle, the ground lead must be connected to the ground prong only. If the line cord comes with a three-prong plug, connect to a grounded mating receptacle. Never remove the ground prong from a plug, or use a plug with a broken ground prong.

2. Connectors

Fully insulated lock-type connectors should be used to join welding cable lengths.

3. Cables

Frequently inspect cables for wear, cracks, and damage. **IMMEDIATELY REPLACE** those with excessively worn or damaged insulation to avoid possibly lethal shock from bared cable. Cables with damaged areas may be taped to give resistance equivalent to original cable.

Keep cable dry, free of oil and grease, and protected from hot metal and sparks.

4. Terminals and Other Exposed Parts

Terminals and other exposed parts of electrical units should have insulating covers secured before operation.

5. Electrode Wire

Electrode wire becomes electrically HOT when the power switch of gas metal-arc welding equipment is ON and welding gun trigger is pressed. Keep hands and body clear of wire and other HOT parts.

6. Safety Devices

Safety devices such as interlocks and circuit breakers should not be disconnected or shunted out.

Before installation, inspection, or service of equipment, shut OFF all power, and remove line fuses (or lock or red-tag switches) to prevent accidental turning ON of power. Disconnect all cables from welding power source, and pull all 115 volts line-cord plugs.

Do not open power circuit or change polarity while welding. If, in an emergency, it must be disconnected, guard against shock burns or flash from switch arcing.

Leaving equipment unattended. Always shut OFF, and disconnect all power to equipment.

Power disconnect switch must be available near the welding power source.

ABOUT THIS GUIDE

This Weld Control Selector Guide is designed to aid in selection and installation of various weld controls and Cobramatic feeders. The most popular power supplies from various manufacturers are covered, however, many others are not. The power supplies not covered in this guide can also be hooked up to Cobramatic feeders by modifying the connections. Spool-guns may also be hooked up by using a WC-1 control box. The exception to this is "synergic" type of power supplies. There are two types of "synergic" units. If the controls for the power supply are on the power supply, then a Cobramatic II feeder may be adaptable. If the controls for the power supply are incorporated into that manufacturer's wire feeder, then it becomes difficult to hook up a different type of feeder.



CAUTION :

When working with voltages present in this product and others, always observe warning and caution signs. Service must only be performed by qualified service personnel.

DISCLAIMER

At the time of its printing the information in this guide was accurate according to the information provided by the various manufacturers. Due to model variations, modifications and other unknowns, this information may not be accurate in all cases. **Refer to the power supply owner's manual if there are any questions or doubts about proper hook-up.** Upon using this guide the user accepts full responsibility of the consequences that may occur during hook-up. **All work should only be attempted by a qualified service technician with the proper tools and knowledge of electronics.**

WHY DO I NEED A WELD CONTROL?

The weld control provides the electronics needed to operate the spool gun, as well as, provide the contactor signal to activate the power supply. In a GMAW (MIG) system the wire is not electrically hot until the welder activates the trigger. The weld control then sends the contactor signal to energize the power supply.

There are two types of contactor signals that various power supply manufacturers use. The first is a "Closing Contact" signal. With this type of signal the weld control simply touches the two contactor leads together (providing continuity to the power supply). The second type of signal is the "115VAC" signal. With this type of signal the weld control sends 115 volts AC to the power supply. If you were to touch the contactor leads in this position, you would get a SHOCK when the trigger is activated. All GTAW (TIG) machines use a closing contact signal because it would be unsafe to put a 115VAC contactor signal in a foot control.

WHICH WELD CONTROL?

The WC-1 can be used on all power supplies, although it may not be the most economical or most feasible approach. Where possible, a dedicated weld control has been developed to simplify installation and lower cost. These controls interface to a particular power supply or a group of power supplies from a certain manufacturer.

HOW TO USE THIS GUIDE

1. Using the charts on pages 1 thru 5, locate the power supply you wish to connect to.
2. The next column over will indicate which control is needed for the Prince XL Spool-gun. Sometimes, an optional control is available. This will be indicated in the third column. The fourth column will list any special notes. **Note: For Cobramatic feeders a weld control is not needed**, however, if a contactor box is listed it should be used.
3. Check the notes column for important information.
4. Check the hook-up instructions column for the section, then go to that section.
5. The Posa Start on the Cobramatic feeders can be used with all CV/CC power supplies by simply connecting the single black lead extending from the back of the unit to work ground (-).
6. **Reference the Appendix for connection information to many utility type welders.**

Table of Contents

Power Supply Listing	1
Airco	7
Esab	9
Hobart	12
Lincoln	14
Miller	18
Powcon	21
Panasonic	23
Thermal Dynamics	24
Appendix	25
Warranty	

This page intentionally blank.

Weld Control Selector Guide

Power Supply	Control Required	Optional	Notes*	Section
Miller Electric				
Millermatic 35, Spoolmate 200	I			M-5
Millermatic 200, Regency 250, 300, 350	A		1, 6, 7	M-1, 3, 5
Millermatic 250, Vintage	C			M-6
Millermatic 250-X, 251	D			M-5, 6
CP-200, 250TS, 300, 302, MC-300VS	A		1,6, 7	M-1, 2, 3
Shopmaster 300	A		7	M-1, 3
All Delta Welds, Pulstar 450, IntelliWeld 650	A		1, 6, 7	M-1, 3, 5
Arc Pak 350	A		1, 6, 7	M-1, 3
XMT-200, 300, 304 (Optima Excluded)	A		6, 7, 8	M-1, 3
XMT-300CC & CC/TIG	I		2, 7, 8	M-4
Maxtron 300, 400	A		6, 7, 8	M-1, 3
All Maxstars (except 140 & 200)	I		2	M-4
Dimension 400	A		1, 6, 7	M-1, 2, 3
MP30E, MP45E, MP65E, 300MT	I			M-2
All Gold Star SS, 320/330 A/BP All Syncro Waves, 300ST Aircrafter	I		2	M-4, 7
Dialarc HF	I	J (Rec.)	2	M-8
Legend AEAD-200LE	I	J (Rec.)	2, 3, 5	M-8
Bobcat 225G, 225NT	I	J (Rec.)		M-8
Trailblazer 250, 251, Air Pak	A		1, 6, 7	M-1, 3
Big 30A, 40G/D, 50D with CV-3 installed	I A	J (Rec.) ---	2 6, 7	M-4, 8 M-1, 3
Big Blue 251D, 400D	I	J (Rec.)	2	M-8
Trailblazer 44G/D	I		2	M-8
Trailblazer 55G/D	A		1, 6, 7	M-1, 3
Invision 354, 456MP	A		8	M-1, 3

WELD CONTROLS AVAILABLE

- | | |
|--|---|
| A P/N 005-0261 PA-M1 Spool Gun Control | F P/N 005-0624 MigMaster 251 Kit |
| B P/N 005-0264 PA-G1 Spool Gun Control | I P/N 001-3062 WC-1 Control |
| C P/N 005-0205 MillerMatic Module | J P/N 001-3066 MK200 Contactor |
| D P/N 005-0629 MillerMatic 250/250-X Intfc Cbl | K P/N 005-0617 Gunslinger 260 Intfc Cbl |
| E P/N 005-0206 MigMaster 250 Module | L P/N 005-0676 PA-L1 Spool Gun Control |

Weld Control Selector Guide

Power Supply	Control Required	Optional	Notes*	Section
Lincoln Electric				
SP-150, 200	I			L-1
SP-250	I	B		L-2
Wirematic 250, 255	I	B		L-3
PowerMig 255, 455	I		9	L-7
DC-250, 400, 600, Pulse Power 500	I			L-4
R3S-250, 325, 400	I			L-4, 5
CV-200, 250, 300, 400	I, L		7	L-6
Invertec V300-PRO, V350-PRO (Fac. & Adv.)	L	I	7, 8	L-6
Invertec V350-PRO (Contractor)	I	J (Rec.)	8	L-9
TIG 250/300, Squarewave 300/350	I		2	L-8
Weldanpower 225/250	I	J (Rec.)	2	L-9
G7, G8000, Ranger 8 (Red-D-Arc ZR-8 & ZR-10)	I	J (Rec.)		L-9
G9, D-10 PRO, Classic w/CV Tap	I			L-4
Ranger 9, 10, 10-XL, 250, 275, 305	I, L		7, 10	L-6
Commander 300, 500, Vantage 500	I, L		7, 10	L-6
PowerWave 450, 450-ONE	---		8	L-10

ESAB (Includes L-Tec & Linde)

L-Tec 225	I			E-1
MigMaster 250	E			E-2
MigMaster 251	F		8	E-3
MigMaster 300	I		8	E-4
ESAB 352CV, 452CV	I		8	E-6
ESAB 251CV			8	E-7
MultiMaster 260			8, 12	E-7
Most V, VI, SVI Units	I		8	E-5, 6
L-Tec 300, 400, 450, 650	I			E-5, 6
UCC-301, 305, 306	I		2	E-8
HeliArc 250, 306, 301, 401	I		2, 8	E-8
L-Tec 250 Stick	I	J (Rec.)	2	M-8
ESAB Pulse Arc II-400, 500	I			A-3

WELD CONTROLS AVAILABLE

- | | |
|--|---|
| A P/N 005-0261 PA-M1 Spool Gun Control | F P/N 005-0624 MigMaster 251 Kit |
| B P/N 005-0264 PA-G1 Spool Gun Control | I P/N 001-3062 WC-1 Control |
| C P/N 005-0205 MillerMatic Module | J P/N 001-3066 MK200 Contactor |
| D P/N 005-0629 MillerMatic 250/250-X Intfc Cbl | K P/N 005-0617 Gunslinger 260 Intfc Cbl |
| E P/N 005-0206 MigMaster 250 Module | L P/N 005-0676 PA-L1 Spool Gun Control |

Weld Control Selector Guide

Power Supply	Control Required	Optional	Notes*	Section
Hobart (Includes ThermalArc)				
BetaMig 200	B			H-1
BetaMig 250, 251	I			H-2
BetaMig 2510, IronMan 250	C			H-2 M-6
Mega Mig RC/RBS, Fabstar	I			H-3 HT-1,2
Hobart Excel Arc CV, CV/CC	I			H-3 HT-1,2
Fabricator 210, 300LF	I		11	T-2 M-1
Fabricator 250	I			T-2
Mega Flex RCC/RVS	I			H-3 HT-1
CyberTig, CyberWave	I		2	H-4
Porta-Tig/Stick	I		2	H-4
TR-250	I	J (Rec.)	2	M-8
TR-250HF	I		2	H-4
TigWave 250, 350	I		2	H-4
Champion/Titan Combo	I			H-4
Champion Fabshop	I		2	H-4
Champion 16, 16D, 18	I	J (Rec.)	2	H-4
Mega Arc Engine Driven	I	J (Rec.)	2, 5	M-8
Hobart DCC 353P	I			H-3
Titan 7000, 8000 AC/DC	I	J (Rec.)	2	M-8

Thermal Dynamics (Includes ThermalArc)

300GMS, 400SMT, 400SMT-W	A		6	T-2 M-3
Fabricator 210, 250	P/N 005-0689		11	
Fabricator 310LF	I			T-2 M-1
Fabricator 2620, 4030	I			HT-1, 2
Viking 210, 250GM	I	P/N 003-1623		T-1
Excel Arc CV, CV/CC; Arc Master 351, 501	I			HT-1, 2
PowerMaster	I			HT-1, 2 M-3
Predator, Explorer (w/o Contactor)	I	J (Rec.)		T-3
Exciter, Hog	I	J (Rec.)		T-3
Predator, Explorer, Hercules, T-Bird (w/contactor)	A, I			HT-1 M-1

WELD CONTROLS AVAILABLE

- | | |
|--|---|
| A P/N 005-0261 PA-M1 Spool Gun Control | F P/N 005-0624 MigMaster 251 Kit |
| B P/N 005-0264 PA-G1 Spool Gun Control | I P/N 001-3062 WC-1 Control |
| C P/N 005-0205 MillerMatic Module | J P/N 001-3066 MK200 Contactor |
| D P/N 005-0629 MillerMatic 250/250-X Intfc Cbl | K P/N 005-0617 Gunslinger 260 Intfc Cbl |
| E P/N 005-0206 MigMaster 250 Module | L P/N 005-0676 PA-L1 Spool Gun Control |

Weld Control Selector Guide

Power Supply	Control Required	Optional	Notes*	Section
Powcon				
200SM	B		6	P-2
300SM	I			P-1
300T, 300SS	I		2	P-4
400SS	I		2	P-5
400SM, 400SMT, 630SMP	B		1, 6	P-3
500SM, 500SM AC/DC	B		6	P-3
500MP	I			P-1
Plasma +, 225SMC (Single Phase)	B		6	P-2
Plasma +, 225SMC (Three Phase)	I			P-1
Panasonic				
Gunslinger 260	K			PA-1
Airco				
Dip-Pak 200, 225, 250	B		6	A-1
Dip-Cor 300	I			A-2
CV-200, 250, 300, 450, 600	I			A-3
PA-3A, PulseArc 350, 400, 500	I		4	A-3
Pulse Arc II400, 500	I			A-3
Phase Arc 350, 550, 650	I			A-3
AC/DC Heli-Welders	I		2	A-4
AC/DC Square Waves	I		2	A-4

WELD CONTROLS AVAILABLE

- | | | | |
|---|--|---|---------------------------------------|
| A | P/N 005-0261 PA-M1 Spool Gun Control | F | P/N 005-0624 MigMaster 251 Kit |
| B | P/N 005-0264 PA-G1 Spool Gun Control | I | P/N 001-3062 WC-1 Control |
| C | P/N 005-0205 MillerMatic Module | J | P/N 001-3066 MK200 Contactor |
| D | P/N 005-0629 MillerMatic 250/250-X Intfc Cbl | K | P/N 005-0617 Gunslinger 260 Intfc Cbl |
| E | P/N 005-0206 MigMaster 250 Module | L | P/N 005-0676 PA-L1 Spool Gun Control |

Weld Control Selector Guide

Notes:

1. Miller power supply must have 14 pin Amphenol or the WC-1 **must** be used. See WC-1 hookup, section M-2.
2. **Constant current (CC) power supplies can only be used in spray transfer mode with ALUMINUM and CORED wire only.**
3. These power supplies put out less than 24VAC to the spool gun therefore maximum speed will not be obtained. This means 3/64 diameter wire should be used when welding materials thicker than 1/4.
4. Must be used in the non "synergic" mode.
5. Contactor box not needed if power supply has optional remote control facilities (panel).
6. WC-1 Weld Control can also be used.
7. An adapter cable with Amphenol already attached can be used with the power supply and WC-1 or Cobramatic combination.
8. Many of the newer power supplies, especially the inverter style units now use a Dinse style connector for the weld power out. This means the lug on the power cable of the Spool-gun must be cut-off and replaced by a male Dinse connector (MK P/N: 153-0755).
9. MK does not make a weld control for the Lincoln PowerMig 255. Since Lincoln makes their own control for a Prince XL Spool-gun, they furnish the control module with the Spool-gun. However the WC-1 or the MK Cobramatic Cabinet may be used with that unit (See L-7).
10. At this time, the Lincoln Commander 300 and 500 does not have 42VAC volts at the 14-Pin connector. An optional kit (P/N: K1597-1) must be obtained from Lincoln in order to use the Prince® XL spool gun with the PA-L1. Units with a date code of November 2001 have 42VAC.
11. If the Fabricator 210 has a 4 digit specification number (xxxx), then the 14-Pin Control will work. If the 4 digit specification has an "A" at the end (xxxxA), then a WC-1 Control must be used. (See H-2)
12. To use an MK 003-1341 Adapter, the Multimaster 260 requires the optional ESAB spool gun control module. Units after S/N 0558001793 come standard with the Spool Gun Module.
13. The Classic Series engine driven welder is a CC type power supply. To properly operate this unit while welding aluminum, the CV tap is required. However, because 42VAC is unavailable a WC-1 Weld Control must be used.

WELD CONTROLS AVAILABLE

A	P/N 005-0261 PA-M1 Spool Gun Control	F	P/N 005-0624 MigMaster 251 Kit
B	P/N 005-0264 PA-G1 Spool Gun Control	I	P/N 001-3062 WC-1 Control
C	P/N 005-0205 MillerMatic Module	J	P/N 001-3066 MK200 Contactor
D	P/N 005-0629 MillerMatic 250/250-X Intfc Cbl	K	P/N 005-0617 Gunslinger 260 Intfc Cbl
E	P/N 005-0206 MigMaster 250 Module	L	P/N 005-0676 PA-L1 Spool Gun Control

This page intentionally blank.

The PA-G1 Control (P/N 005-0264) is connected to the Dip-Pak 200 as follows:

1. Connect the **red** and **green** contactor leads extending from the Control to the spade connectors located next to the wire feed motor; **red** to wire to the left spade and **green** wire to the right spade.
2. Connect the **black** wire extending from the Control to the left spade along with the red and the **white** wire to #3 on the terminal strip located above the wire feed motor.
3. Set the unit on "MANUAL" and adjust the voltage using the "UP & DOWN" push-button.
4. Place Wire Feed/Midget Switch to "MIDGET" position.

Note: The feeder inside this unit will also be turned on, so disengage the spring tension on drive roll.

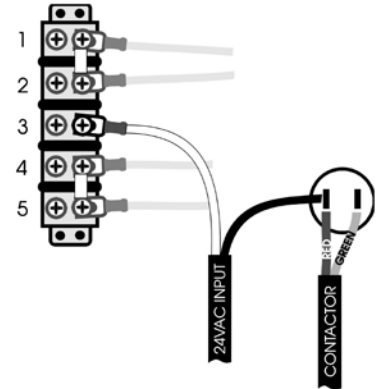

The PA-G1 Control (P/N 005-0264) is connected to the Dip-Pak 225 as follows:

1. Remove the left panel and locate pin 1 of terminal strip (where all blue wires converse). Add a wire from pin 1 and route it through the access hole on the center panel into the left side. Connect the added wire to terminal strip TB 2 #16 located above the wire feed motor.
2. Connect the **green** contactor lead extending from the Control to TB2 #22 and the **red** contactor lead to TB2 #21.
3. Connect the **black** wire extending from the Control to TB2 #21 and the **white** wire to TB2 #16.

Note: The feeder inside this unit will also be turned on, so disengage the spring tension on drive roll.

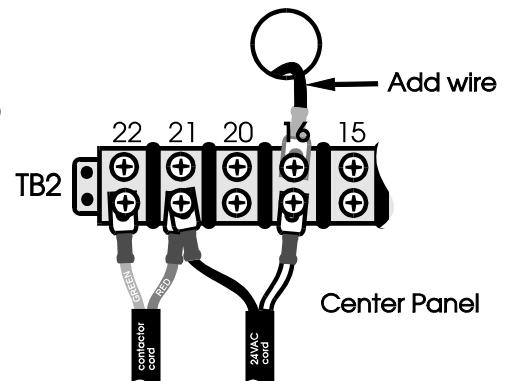

The PA-G1 Control (P/N 005-0264) is connected to the Dip-Pak 250 as follows:

1. Remove the left panel. Splice the **red** and **green** contactor leads extending from the Control to the brown and blue wires extending from the front panel amphenol; **red** to wire to **blue** and **green** wire to **brown**.
2. Locate TB-1 (an 8 position terminal strip inside unit). Connect the **black** wire extending from the Control to TB1 #1 and **white** wire to #3.
3. Set the switch inside the Dip-Pak wire feed compartment to "Spoolgun"
4. Connect the spoolgun power lug to the front connector or to the bolt next to the wire feed motor.

Note: Splice and fork connectors are included in Control kit.

THE WC-1 OR COBRAMATIC CAN ALSO BE CONNECTED TO THESE UNITS BY SIMPLY CONNECTING THE CONTACTOR AND PLUGGING THE UNIT INTO A STANDARD WALL OUTLET. (Both the WC-1 or Cobramatic Contactor will be in CLOSING CONTACTS position, see Appendix for contactor information.)

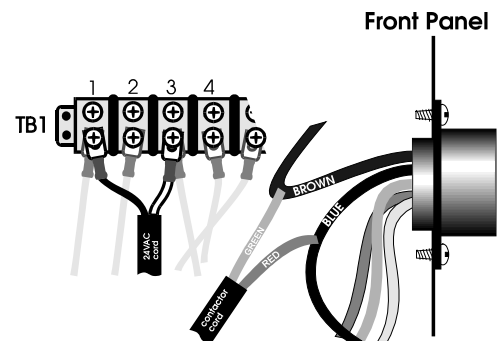

Airco

A-2

The WC-1 Weld Control or the Cobramatic Cabinet can be connected to the Dip-Cor 300 as follows:

1. Connect the **black** and **white** contactor leads extending from the WC-1 or Cobramatic to the spade connectors located on the center panel below the wire feed motor. Place the contactor in the CLOSING CONTACTS position (see Appendix for contactor information).
2. Plug the 115VAC plug extending from the WC-1 or Cobramatic into a standard wall outlet.
3. Tape off WC-1 **red** and **green** leads and turn off Posa Start switch as Posa Start is not used.

Note: The feeder inside these units will also be turned on, so disengage the spring tension on the drive roll.

A-3

Airco CV power supplies use a two-prong twist lock for the contactor. Some units have a standard wall outlet 115VAC plug.

1. To hook-up the WC-1 or Cobramatic to these units connect the **black** and **white** contactor leads extending from the WC-1 or Cobramatic to the two-prong twist lock plug (**black** to hot & **white** to neutral). Change the contactor to the 115VAC position (see Appendix for contactor information).
2. Plug the 115VAC plug extending from the WC-1 or Cobramatic into a standard wall outlet.
3. Tape off WC-1 **red** and **green** leads and turn off Posa Start switch as Posa Start is not used.
4. If the power supply has a Remote/Standard contactor switch set it to "REMOTE".

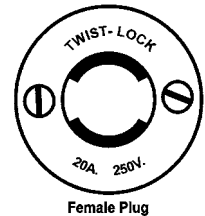

Two Prong Plug	
Miller	039-635
Hubbel	7101

Note: On Pulse Arc series machines:

1. Place remote pendant Wire Speed switch in "MANUAL".
2. Use Voltage Trim for voltage control.
3. Use spoolgun wire speed knob to adjust wire speed.

A-4

The WC-1 Weld Control or the Cobramatic Cabinet can be connected to Airco CC power supplies as follows:

Airco has used a variety of contactor plugs over the years. (On some older units, a 6-Pin Cinch-Jones plug was popular. The WC-1 or Cobramatic contactor leads would go to pins 1 and 3.)

All TIG machines use CLOSING CONTACTS!

1. Connect the **black** and **white** contactor leads extending from the WC-1 OR Cobramatic to the remote foot control receptacle. Using the owner's manual or the foot control find out which leads go to the switch inside the foot control; this is where the contactor leads will be connected on the front panel receptacle. Place the WC-1 or Cobramatic in the CLOSING CONTACTS position (see Appendix for contactor information).
2. Plug the 115VAC plug extending from the WC-1 or Cobramatic into a standard wall outlet.
3. *Connect the **red** and **green** leads from the WC-1 to the power supply positive (+) and negative (-) terminals of the power supply; **red** to **positive (+)** and **green** to **negative (-)**.
4. If the power supply has a Remote/Standard contactor switch set it to "REMOTE".
5. Set the amperage control to "panel" and the process switch to "TIG".
6. Place polarity switch to DC Reverse Polarity (electrode positive).

Required Plug

Check the owner's manual for the correct plug part number. The plug will be found on the end of the foot control cable.

*See Appendix for Cobramatic Posa Start information.

CAUTION: MAKE SURE THAT THE HIGH FREQUENCY IS TURNED OFF OR DAMAGE TO THE WC-1 OR COBRAMATIC WILL OCCUR.

ESAB (Includes L-Tec & Linde)

E-1

The older L-Tec 225 is connected as follows:

1. Install 1/4 (.250) wide female spade connectors to the **Black** and **White** contactor wires extending from the WC-1 Weld Control or the Cobramatic Cabinet to the male spade connectors located on the inside wall of the welder by the wire feeder. First remove the existing trigger leads from the L-Tec torch. Place the WC-1 or Cobramatic in the CLOSING CONTACTS position (see Appendix for contactor information).
2. Plug the 115VAC plug extending from the WC-1 or Cobramatic into a standard wall outlet.

Note: The feeder inside this unit will also be activated so disengage the spring tension on the drive roll.

E-2

The 005-0206 Kit will interface a Prince XL Spool-gun to a Migmaster 250. It plugs directly into the amphenol on the front of the unit and includes everything needed to interface to that power supply. A Cobramatic system may be used on this unit and would be interfaced as follows:

1. Plug the 115VAC plug from the Cobramatic Cabinet into a standard wall outlet.
2. Connect the **black** and **white** contactor leads from the Cobramatic Cabinet to the 8-Pin (Spool-gun) plug on the Migmaster 250: the **black** wire to Pin **A** and the **white** wire to Pin **B**. Put the Cobramatic in CLOSING CONTACTS Position (see Appendix for contactor information).

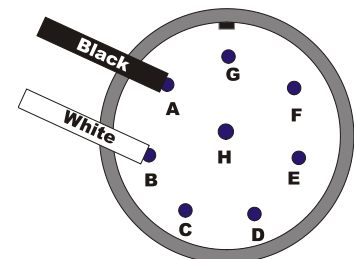

Note - The power cable to the Cobramatic hooks to bolt holding an existing cable just in front of the MM-250's wire feed motor. Place the Switch (Std/Spool-gun) in Spool-gun position.

8-Pin Amphenol	
Socket	153-0922
Cord Clamp	411-0191
Rubber Boot	301-0054

E-3

The 005-0624 Kit will interface a Prince XL Spool-gun to a Migmaster 251. It replaces a blank panel on the front of the machine and includes everything needed to interface to this welder.

A Cobramatic system may be used on this unit and would interface as follows:

1. Plug the 115VAC plug from the Cobramatic Cabinet into a standard wall outlet
2. Install 1/4 (.250) wide female spade connectors to the **Black** and **White** contactor wires extending from the Cobramatic Cabinet to the male spade connectors located on the inside wall of the welder by the wire feeder. First remove the existing trigger leads from the Migmaster torch. Place the Cobramatic in the CLOSING CONTACTS position (see Appendix for contactor information).
3. Place the power cable lug from the Cobramatic Cabinet on the positive (+) terminal of the Migmaster 251 located by the wire feeder inside the welder.

E-4

The WC-1 Weld Control of the Cobramatic Cabinet may be connected to the Migmaster 300 as follows:

1. Plug the 115VAC plug from the WC-1 Weld Control of the Cobra Cabinet into a standard wall outlet.
2. Connect the **Black** and **White** contactor leads from the WC-1 or Cobramatic to the 8-Pin plug on the Migmaster 300. The **black** wire to **Pin A** and the **white** wire to **Pin B**. Put the WC-1 or Cobramatic into CLOSING CONTACTS position (see Appendix for contactor information).
3. A male Dinse style connector is required on this machine. Cut the lug off of the power cable on the Prince XL Spool-gun and replace with the Dinse connector.

8-Pin Amphenol	
Socket	153-0922
Cord Clamp	411-0191
Rubber Boot	301-0054
Dinse Connector	
Male Plug	153-0755

ESAB (Includes L-Tec & Linde)

E-5

The older Linde CV machines are connected as follows:

1. Connect the **black** and **white** contactor leads extending from the WC-1 Weld Control or the Cobramatic Cabinet to the 6-Pin metal Pyle-National plug; **black** to **pin 3** and **white** to **pin 5**. Place WC-1 or Cobramatic in the 115VAC CONTACTOR position (See Appendix for changing contactor).
2. Plug the 115VAC plug extending from the WC-1 or Cobramatic into a standard wall outlet or cut off the plug and wire the **black** wire to **pin 1**, the **white** wire to **pin 2** and the **green** wire to **pin 4**.
3. Tape off WC-1 **red** and **green** leads and turn off Posa Start switch as Posa Start is not used.

Pyle National "Triploc"	
Male Plug	AP-610
Housing	APD-2004

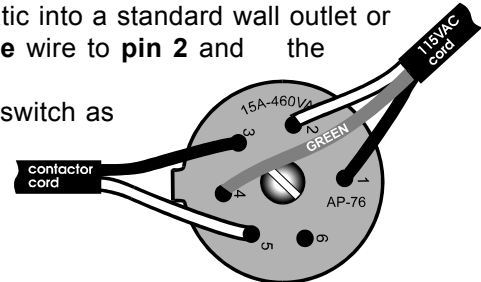

E-6

The newer ESAB/Linde/L-Tec CV machines are connected as follows:

1. Connect the **black** and **white** contactor leads extending from the WC-1 Weld Control or Cobramatic Cabinet to the 7-Pin plastic AMP plug; **black** to **pin 1** and **white** to **pin 3**. Place WC-1 or Cobramatic in the CLOSING CONTACTS position (see Appendix for contactor information).
2. Plug the 115VAC plug extending from the WC-1 or Cobramatic into a standard wall outlet or cut off the plug and wire the **black** wire to **pin 1**, the **white** wire to **pin 2** and the **green** wire to **pin 4**.
3. Tape off WC-1 **red** and **green** leads and turn off Posa Start switch as Posa Start is not used.

7-Pin Amp Connector		
	L-Tec P/N	AMP P/N
7-Pin Plug	674655	206226-1
Cord Clamp	674568	206138-1
Pins (4 req.)	674564	66255-1

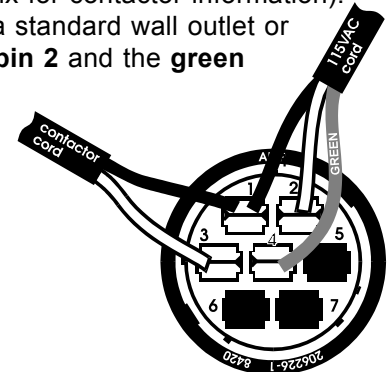

Some ESAB/L-TEC CV/CC machines have 19 pin (J1) amphenols and are connected as follows:

1. Connect the **black** and **white** contactor leads extending from the WC-1 or the Cobramatic to the 19 pin amphenol plug; **black** to **pin A** and **white** to **pin C**. Place WC-1 or Cobramatic in the CLOSING CONTACTS position (see Appendix for contactor information). Pins **U** & **V** can also be used for contactor.
2. Plug the 115VAC plug extending from the WC-1 or Cobramatic into a standard wall outlet or cut off the plug and wire the **black** wire to **pin A**, the **white** wire to **pin B** and the **green** wire to **pin D**. The MultiPower 460 units do not supply 115VAC at the 19-Pin.
3. Tape off WC-1 **red** and **green** leads and turn off Posa Start switch as Posa Start is not used. On the Cobramatic System hook up the Posa-Start lead to the Power Supplies ARC GROUND and use PosaStart when welding aluminum only.

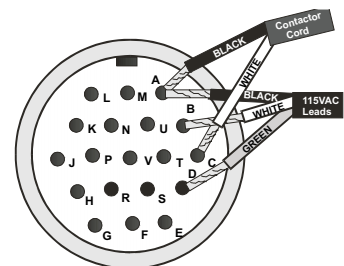

19-Pin Amphenol		
	MK P/N's	Amphenol P/N's
19-Pin Plug	153-0314	3106A22-14P
Cord Clamp	411-0035	3057-1012
Rubber Boot	301-0026	MS3420-12

P/N 005-0614
Complete 8' cable with 19P Amphenol attached.
Easily connects to SVI 450 (115VAC on 19-Pin).

Note: Use in CV-Mig mode and be sure that nothing is plugged into J2 (8-Pin).

The Prince XL Spool-gun may be hooked up to the ESAB 251cv Power Supply using the welders built-in speed control module. This is accomplished by using a MK adapter pigtail (P/N 003-1341) which will plug directly into the ESAB power supply's 8-Pin amphenol on the front of the machine.

The lug on the Prince XL's power cable will have to be cut off and replaced by a male Dinse connector (MK P/N: 153-0755). There's a switch on the front upper panel that has to be in the Spool-gun position. If the Multimaster 260 has ESAB's optional spool gun module already installed, then the 003-1341 MK adapter pigtail will work.

A Cobramatic system may be connected to this power supply. Use the instructions found in section E-2 for the Cobramatic system. However, the switch on the upper panel of the welder will have to be in the Spool-gun position.

Do not attempt to hook up the Cobramatic system using the 19-Pin Amphenol on this unit.

The WC-1 Weld Control or the Cobramatic Cabinet can be connected to All L-Tec/Linde TIG/CC) machines as follows: **Note** - Various contactor plugs have been used over the years.

1. Connect the **black** and **white** contactor leads extending from the WC-1 Weld Control or the Cobramatic Cabinet to the remote foot control receptacle on the unit. Using the owner's manual or the foot control find out which leads go to the switch inside the foot control; this is where the contactor leads will be connected on the receptacle.
2. Place WC-1 or Cobramatic in CLOSING CONTACTS position (see Appendix for contactor information).
3. Plug the 115VAC plug extending from the WC-1 or Cobramatic into a standard wall outlet.
4. *Connect the **red** and **green** leads from the WC-1 to the power supply positive (+) and negative (-) terminals of the power supply; **red to positive (+)** and **green to negative (-)**.
5. Place the Weld Control Switch to "INERT GAS or TIG" and the Remote Switch to "PANEL".
6. Set the Polarity Switch to "DC REVERSE POLARITY" (electrode positive).
7. Set the Soft Start to "OFF" and the High Frequency Switch to "OFF".
8. The Posa Start must be used. See WC-1 or Cobramatic owner's manual for Posa Start information.

Required Plug

Check the owner's manual for the correct plug part number. The plug will be found on the end of the foot control cable.

*See Appendix for Posa Start information.

CAUTION: MAKE SURE THAT THE HIGH FREQUENCY IS TURNED OFF OR DAMAGE TO THE WC-1 OR COBRAMATIC WILL OCCUR.

Hobart (Includes ThermalArc)

H-1

The Prince XL Spool-gun may be hooked up to the BetaMig 200 or the BetaMig LF by using the PA-G1 Control (P/N 005-0264) as follows:

1. Open the left side of BetaMig.
2. Splice the **red** and **green** contactor leads extending from the Control to the spade connectors below the wire feed motor on the deck (trigger connection).
3. Remove the right side panel of BetaMig and locate the small control transformer next to the input voltage taps. The transformer is marked 110/110 on one side and 24/24 on the other.
4. Splice the **black** wire extending from the Control to one side of the Spade 24 and the **white** wire to the other Spade 24.

A WC-1 Weld Control or Cobramatic System may be hooked up to these units as follows:

1. Plug the WC-1 or Cobramatic Cabinet 115VAC plug into a standard wall outlet.
2. Install 1/4 (.250) wide female spade connectors to the black and white contactor leads from the Cobramatic Cabinet. Inside the Wire Feeder portion of the BetaMig console, remove the torch trigger leads from the spade connector and plug on the ones from the Cobramatic contactor leads.

Note: The feeder inside these units will also be turned on, so disengage the spring tension on drive roll.

H-2

The BetaMig 2510 Kit (P/N 005-0205) is the same kit for the Millermatic 250 and plugs directly into the front panel on the front of the unit. It includes everything needed to interface to this power supply. However, the printing on the kit identifies it as a Millermatic 250 kit.

A WC-1 Weld Control or Cobramatic System may be hooked up to any of the BetaMig systems above. In each case, the 115VAC plug from the Cobramatic Cabinet must go to a standard wall outlet.

On the BetaMig 250, female spade connectors have to be installed on the WC-1 or Cobramatic Cabinet's contactor leads (CLOSING CONTACTS position) and installed like that listed in H-1 .

On the BetaMig 251 and BetaMig 2510, splice the WC-1 or Cobramatic Cabinet's contactor leads (CLOSING CONTACTS position) to the trigger leads coming from the back of the Hobart's torch connection to the welder.

Note: In all three cases, the feeder inside these unit will also be turned on, so disengage the spring tension on the drive roll.

H-3

The WC-1 Weld Control and the Cobramatic Cabinet is connected to Hobart CV and CV/CC power supplies as follows:

The contactor is always found on pins "A" and "B" regardless of the type of amphenol. Most of the Hobart CV power supplies use a 5-Pin amphenol.

1. Connect the **black** and **white** contactor leads from the WC-1 or Cobramatic to pins A & B of the 5-Pin amphenol; **black** to "A" and **white** to "B". Place the contactor in the CLOSING CONTACTS position (see Appendix for contactor information).
2. Plug the 115VAC plug extending from the WC-1 or Cobramatic into a standard wall outlet.
3. Tape off WC-1 **red** and **green** leads and turn off Posa Start switch as Posa Start is not used.
4. If the power supply has a Remote/Standard contactor switch set it to "REMOTE".

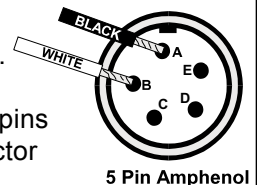

5-Pin Amphenol	
Plug	3106A18-20P
Cord Clamp	3057-1010
Boots	MS3420-10 MS3420-8

Note: If unit is a CV/CC power supply use in the CV mode. If hooking up a Cobramatic Cabinet, it is recommended to hook up and use the PosaStart feature.

Hobart (Includes ThermalArc)

H-4

The WC-1 Weld Control or the Cobramatic Cabinet can be connected to Hobart CC power supplies as follows (The contactor is always found on pins "A" and "B" regardless of the type of amphenol):

All TIG machines use CLOSING CONTACTS!

1. Connect the **black** and **white** contactor leads from the WC-1 or Cobramatic to pins A & B of the remote amphenol: **black** to "**A**" and **white** to "**B**". Place the contactor in the CLOSING CONTACTS position (see Appendix for contactor information).
2. Plug the 115VAC plug from the WC-1 or Cobramatic into a standard wall outlet.
3. Connect the **red** and **green** leads from the WC-1 to the power supply positive (+) and negative (-) terminals of the power supply; **red** to **positive (+)** and **green** to **negative (-)**.
4. If the power supply has a Remote/Standard contactor switch set it to "REMOTE". Set the amperage control to "panel" and the process switch to "TIG".
5. Place polarity switch to DC Reverse Polarity (electrode positive).

5-Pin Amphenol	
Plug	3106A18-20P
Cord Clamp	3057-1010
Boots	MS3420-10 MS3420-8
10-Pin Amphenol	
Plug	3106A18-19P
Cord Clamp	3057-1010
Boots	MS3420-10 MS3420-8

CAUTION: MAKE SURE THAT THE HIGH FREQUENCY IS TURNED OFF OR DAMAGE TO THE WC-1 OR COBRAMATIC WILL OCCUR.

Note: The TR-250 HF uses a 10 pin amphenol and you must **jumper pins D & E together.**

HT-1

Since Hobart was divided up and sold to several different companies; the type of interfacing plug might be different depending on the age of the machines. At one time Hobart put both a 5-Pin and a 19-Pin Amphenol on their units. Then they went strictly to a 5-Pin Amphenol. As other companies came into the picture, some introduced the Miller version of a 14-P Amphenol. Then on some models, both a 5-Pin and a 14-Pin were used. To add to the confusion, some later models have both a 14-Pin and a 19-Pin Amphenol (The Fabstar is a good example of this). The one constant seems that all of these amphenols used CLOSING CONTACTS to pins A and B. Check each particular machine to see what type of amphenol is used. If there are any questions, refer to the machine's Owners Manual and/or check for voltages with a V-O-M. (Volt-Ohmmeter)

HT-2

A WC-1 Weld Control or the Cobramatic Cabinet may be connected to any Thermal-Hobart CV type power supply that has a nineteen (19) pin amphenol.

1. Connect the **black** and **white** contactor leads from the WC-1 or Cobramatic Cabinet to pins **A & B** of the 19-Pin Amphenol; **black** to "**A**" and **white** to "**B**". Place the contactor in CLOSING CONTACTS position (see Appendix for contactor information).
2. Plug the 115VAC plug from the WC-1 or Cobramatic Cabinet into a standard wall outlet or cut off the plug and wire the cord to the 19-Pin Amphenol; **black** to pin "**E**", **white** to pin "**F**", and **green** to pin "**G**".
3. With the WC-1, the Posa-start switch will be in the "OFF" Position and the Red and Green leads will not be used.
4. If the power supply has a Remote/Standard contactor switch, set it to "Remote."

19-Pin Amphenol	
19-Pin	153-0314
Cord Clamp	411-0035
Rubber Boot	301-0026

P/N 005-0630
Complete 8' cable with
19P Amphenol attached.

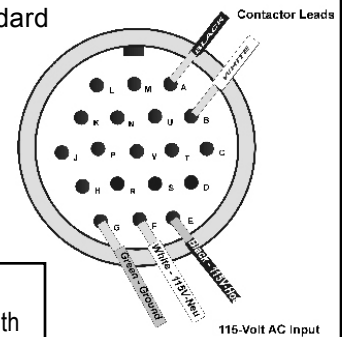

Note: Thermal furnishes 24VAC to pins "D" and "R". This means a spool-gun may be used with a 005-0264 PA-G1 Control on the Thermal-Arc units. Wire a 19-Pin amphenol to PA-G1 Control as follows: the **black** wire to pin "**D**", the **white** wire to pin "**R**", the **red** wire to pin "**A**" and the **green** wire to pin "**B**". (If there are any questions if voltages are or are not available, check the amphenol on the welder with a V-O-M. (Volt-Ohmmeter))

Lincoln Electric

L-1

The SP-150 & 200 are interfaced using the WC-1 Weld Control or the Cobramatic Cabinet as follows:

1. Connect the **black** and **white** contactor leads extending from the WC-1 or Cobramatic to the 4-Pin plug located below the wire feed motor. Place the contactor in the CLOSING CONTACTS position (see Appendix for contactor information).
2. Plug the 115VAC plug extending from the WC-1 or Cobramatic into a standard wall outlet (in some cases 115VAC can be found at the fan motor).
3. Tape off WC-1 **red** and **green** leads and turn off Posa Start switch as Posa Start is not used.

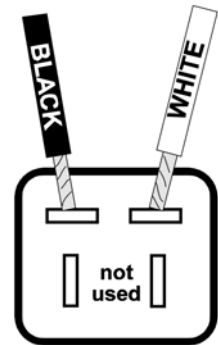

Back side of plug

Four Pin Plug

Cinch-Jones P/N P-304

Lincoln P/N T-10662-1

L-2

The WC-1 Weld Control or the Cobramatic Cabinet can be connected to the SP-250 as follows:

1. Remove the left side panel of SP-250.
2. Splice the **black** and **white** contactor leads from the WC-1 or Cobramatic to the J5 plug located below the wire feed motor; **black** to # 325 and **white** to # 324. Place the contactor in the CLOSING CONTACTS position (see Appendix for contactor information).
3. Plug the 115VAC plug from the WC-1 or Cobramatic into a standard wall outlet.
4. Tape off WC-1 **red** and **green** leads and turn off Posa Start switch as Posa Start is not used.
5. Set the unit on "MANUAL" and adjust the voltage using the "UP & DOWN" push-button.

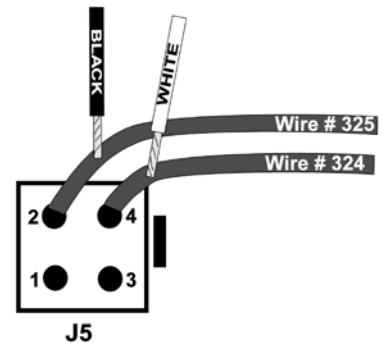

Splice Connectors

MK P/N 153-0818

3M P/N 558 (2 req'd)

Note: The feeder inside the SP-250 will also be turned on so disengage the spring tension on the drive roll.

The PA-G1 Control (P/N 005-0264) can also be connected to the SP-250 as follows:

1. Remove the left side panel of SP-250
2. Splice the **red** and **green** contactor leads extending from the Control to the J5 plug located below the wire feed motor; **red** to wire # 325 and **green** to # 324. The trigger plug on the SP-250 front panel can also be used.
3. Remove the right side panel of the SP-250 and locate red wires # 202 and # 203 going to plug # J6 on the main P.C. board.
4. Splice the **black** wire extending from the Control to wire # 202 and the **white** wire to # 203.
5. Set the unit on "MANUAL" and adjust the voltage using the "UP & DOWN" push-button.

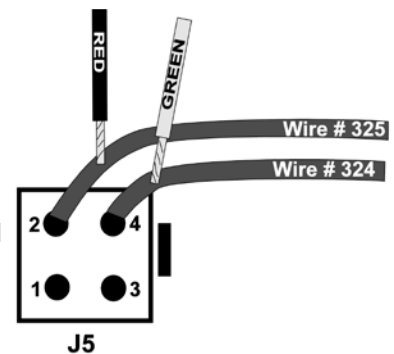

Splice Connectors

MK P/N 153-0818

3M P/N 558 (4 req'd)

- Notes:**
1. Proper operation of the PA-G1 kit is dependant upon the correct input voltage value.
 2. Four of the 153-0818 splice connectors are included in the PA-G1 Control kit.

The Wirematic 250 and Wirematic 255 are interfaced using the WC-1 Weld Control or the Cobramatic Cabinet as follows:

1. Connect the **black** and **white** contactor leads from the WC-1 or Cobramatic to the two solid pins on the 4-Pin Amp plug (trigger plug). Place the contactor in the CLOSING CONTACTS position (see Appendix for contactor information).
2. Plug the 115VAC plug from the unit into a standard wall outlet.
3. Tape off WC-1 **red** and **green** leads and turn off Posa Start switch as Posa Start is not used.
4. Adjust the "VOLTAGE" knob as needed and ignore the "WIRE FEED" knob.

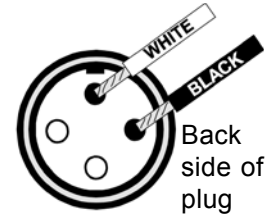

4-Pin Amp		
	MK P/N's	AMP P/N's
Socket	153-0998	206429-1
Cord Clamp	153-0946	206062-3
Pins (2 req.)	153-0958	66099-2/-3

Note: The feeder inside the Wirematic unit will also be turned on, so disengage the spring tension on the drive roll.

The PA-G1 Control (P/N 005-0264) can also be connected to the Wirematic 250 as follows:

1. Remove the left side panel of the Wirematic 250.
2. Splice the **red** and **green** contactor leads extending from the Control to the J5 plug located below the wire feed motor; **red** to wire # 325 and green to # 324.
3. Remove the right side panel of the Wirematic 250 and locate red wires # 202 and # 203 going to plug # J3 on the main P.C. board.
4. Splice the **black** wire extending from the Control to wire # 202 and the **white** wire to # 203.
5. Adjust the "VOLTAGE" control as necessary and ignore the "WIRE FEED" knob on the Wirematic front panel.

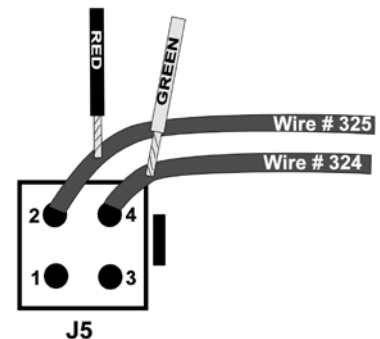

- Notes:**
1. Proper operation of the PA-G1 kit is dependant upon the correct input voltage value.
 2. The feeder inside this unit will also be turned ON, so disengage the spring tension on the drive roll.
 3. Four of the 153-0818 splice connectors are included in the PA-G1 Control kit.

The PA-G1 Control (P/N 005-0264) can also be connected to the SP255 as follows:

1. Remove the hinged lid and right side panel of the SP255.
2. Locate Plug J3 on the main PC Board (lower center). Find the **red** wires # 202 (goes to plug J3 - pin 1) and # 203 (goes to J3 - pin 3).
3. Splice the **black** wire extending from the Control to the **red** wire # 202 and the **white** wire to the red wire # 203.
4. Locate trigger lead plug J13. It is a connector plug coming through the center divider of SP255. It can be found just forward of the upper left side of the main PC Board. There'll be a 6-Pin plug and just below it a 4-Pin plug. The 4-Pin plug is J13. Splice the **red** to wire #325 PIN #2 and the **green** to wire #324 PIN #4.
5. Replace the right side panel and hinged lid.
6. The easiest way to mount the PA-G1 Control is on the side of the unit and to bring the wires from the Control through the louvres on the front of the unit.
7. Adjust the "VOLTAGE" control as necessary and ignore the "WIRE FEED" knob on the Wirematic front panel.

- Notes:**
1. Proper operation of the PA-G1 kit is dependant upon the correct input voltage value.
 2. The feeder inside this unit will also be turned ON, so disengage the spring tension on the drive roll.
 3. Four of the 153-0818 splice connectors are included in the PA-G1 Control kit.

Lincoln Electric

L-4

For all Lincoln CV power supplies except the R3S-325 the following applies. See section L-5 for the R3S-325.

1. Connect the **black** and **white** contactor leads from the WC-1 or Cobramatic to the terminal strip on the Lincoln power supply; **black** to **2** & **white** to **4**. Place WC-1 or Cobramatic in CLOSING CONTACTS position (see Appendix for contactor information).
2. Plug the 115VAC plug from the WC-1 or Cobramatic into a standard wall outlet or cut off the plug and wire **black** to **31**, **white** to **32** and **green** to **ground lug**.
3. Tape off WC-1 **red** and **green** leads and turn off Posa Start switch as Posa Start is not used.

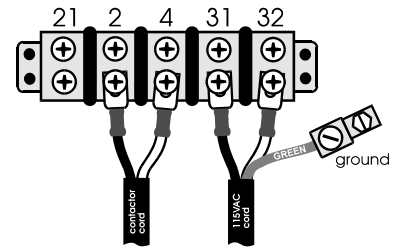

Note: Some Lincoln gas drives use slightly different numbering on the terminal strip. However, 2 & 4 are still the contactor and 31 & 32 are still the 115VAC. If using a gas drive in CC mode red and green Posa Start leads must be connected. (see section L-8, 9).

L-5

For the Lincoln R3S-325 the following applies.

1. Connect the **black** and **white** contactor leads extending from the WC-1 or Cobramatic to the terminal strip on the R3S-325; **black** to **32** & **white** to **4**. Place the unit in CLOSING CONTACTS position (see Appendix for contactor information).
2. Plug the 115VAC plug extending from the WC-1 or Cobramatic into a standard wall outlet or cut off the plug and wire **black** to **31**, **white** to **32** and **green** to **ground lug**.
3. Tape off WC-1 **red** and **green** leads and turn off Posa Start switch as Posa Start is not used.

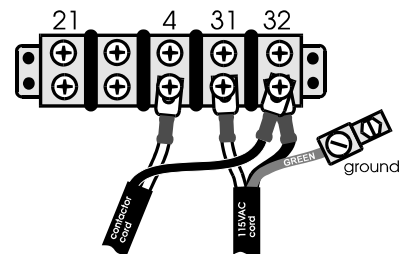

L-6

The PA-L1 Control (P/N 005-0676) comes equipped with a 14 Pin (X-clocked) amphenol connector and simply plugs into any Lincoln CV-type welder that has a 14 Pin (X) socket. This unit operates on 42 volts and is for "CV" only. If the welder has a remote voltage control, it should be set on "Panel". The contactor switch should be on "Remote". Most of the newer Lincoln shop machines now use a dinse style connector (MK P/N 153-0755) which would have to replace the lug on the power cable of the Prince XL spool gun.

New Lincoln power supplies use a 14-Pin (X clocked) amphenol similar to the Miller machines, however, the pins are clocked differently than the Miller (S clocked) amphenol.

1. Connect the **black** and **white** contactor leads from the WC-1 or Cobramatic to the 14-Pin amphenol; **black** to **D** & **white** to pin **C**. Place unit in CLOSING CONTACTS position (see Appendix for contactor information).
2. Plug the 115VAC plug from the WC-1 or Cobramatic into a standard wall outlet or cut off the plug and wire **black** to **J**, **white** to **A** and **green** to pin **B**.
3. Tape off WC-1 **red** and **green** leads and turn off Posa Start switch as Posa Start is not used.

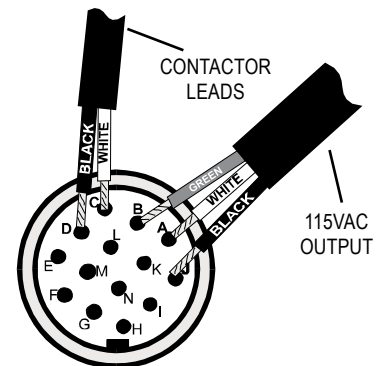

Note: If unit does not have a 14-Pin see section L-4 .

P/N 005-0608
Complete 8' cable with 14P
(X clocked) Amphenol attached.

P/N 005-0659
Complete 25' cable with 14P
(X clocked) Amphenol attached.

14-Pin Amphenol	MK P/N's	LE P/N's
Socket	153-1161	S-12020-32
Cord Clamp	411-0035	S-12024-2
Rubber Boot	301-0021	---

Lincoln Electric

L-7

A Cobramatic Cabinet and Torch can be used in conjunction with the Lincoln PowerMig 255: If a user already has a Prince Spool-gun with a WC-1 Control, The WC-1 would be hooked up the same.

1. Since there's no 115VAC easily available on the PowerMig 255, Plug the 115VAC plug from the WC-1 or Cobramatic into a standard wall plug.
2. Connect the **black** and **white** contactor leads from the WC-1 or Cobramatic Cabinet to the two solid pins on the 4-Pin (Same Plug as listed in L-3) Plug located inside the door of the PowerMig 255. Place the contactor in the CLOSING CONTACTS position (see Appendix for contactor information).

Note: The feeder inside the PowerMig 255 will also be turned on, so disengage the spring tension on the drive roll assembly.

L-8

The WC-1 Weld Control or the Cobramatic Cabinet can be connected to All Lincoln TIG machines as follows: Lincoln has used three types of contactor plugs over the years. The very old machines used a two-prong plug; then came a 5-Pin amphenol, followed by a 6-Pin amphenol.

1. If the power supply has a two-prong twist lock, connect the **black** and **white** contactor leads from the WC-1 or Cobramatic to the two-prong plug (color code not important). If the power supply has either the 5-Pin or the 6-Pin amphenol the **black** and **white** contactor leads usually go to pins D and E; **black** to **D** & **white** to pin **E** (consult unit owners manual).
2. Place unit in CLOSING CONTACTS position (see Appendix for contactor information).
3. Plug the 115VAC plug from the WC-1 or Cobramatic into a standard wall outlet.
4. *Connect the **red** and **green** leads from the WC-1 to the power supply positive (+) and negative (-) terminals of the power supply; **red** to **positive (+)** and **green** to **negative (-)**.
5. Place the Weld Control Switch to "INERT GAS or TIG" and the Remote Switch to "PANEL".
6. Set the Polarity Switch to "DC REVERSE POLARITY" (electrode positive).
7. Set the Soft Start to "OFF" and the High Frequency Switch to "OFF".

*See Appendix for Posa Start information.

Required Plug

Check the owner's manual for the correct plug part number. The plug will be found on the end of the foot control cable.

Lincoln 6-Pin Amphenol	S-12020-27
MK Cord Clamp	411-0191

CAUTION: MAKE SURE THAT THE HIGH FREQUENCY IS TURNED OFF OR DAMAGE TO THE WC-1 OR COBRAMATIC WILL OCCUR.

L-9

The WC-1 Weld Control or the Cobramatic Cabinet can be connected to Lincoln CC power supplies that do not have contactors (stick machines) as follows:

With both the WC-1 or the Cobramatic, a **Contactor box is recommended:**

1. Connect the WC-1 or Cobramatic to the contactor box as shown in the Appendix.
2. Connect the spool gun power lug to the contactor box "TORCH" side and the positive (+) lead from the power supply to the "+ WELD POWER" side.
2. Plug the 115VAC plug from the WC-1 or Cobramatic into a standard wall outlet.
3. *Connect the **red** and **green** leads from the WC-1 to the power supply positive (+) and negative (-) terminals of the power supply; **red** to **positive (+)** and **green** to **negative (-)**.
4. Place polarity switch to DC Reverse Polarity (electrode positive).
5. The Posa Start must be used. See WC-1 or Cobramatic owner's manual for Posa Start information.

*See Appendix for Cobramatic Posa Start information.

L-10

The PowerWave 450 Kit (P/N 005-0254) connects directly to the 120VAC Cobramatic Wire Feed Cabinets, 150-003 and 150-004.

The PowerWave 450 Kit (P/N 005-0315) connects directly to the 42VAC Cobramatic Wire Feed Cabinets 150-203 and 150-204.

The PowerWave 450 Kit (P/N 005-0322) connects directly to the Lincoln Cobramatic Wire Feed Cabinets K1587-1.

Miller Electric

M-1

The PA-M1 Control (P/N 005-0261) comes equipped with a 14-Pin amphenol and simply plugs into the Miller power supply. If the unit is a CV/CC power supply operate in the "CV" mode; have the remote voltage selector on "panel" and the contactor selector on "14- Pin". **Note** - On the XMT series machines, a Dinse style connector (MK P/N 153-0755) would have to replace the lug on the power cable of the spool-gun.

M-2

Older style Miller CV power supplies without 14-Pin amphenols used a two prong twist lock for the contactor and a three prong twist lock supplied an auxiliary 115VAC. Some units also had a standard wall outlet 115VAC plug which can be used instead of the three prong plug.

1. To hook-up the WC-1 Weld Control or the Cobramatic cabinet to these units connect the **black** and **white** contactor leads from the unit to the two prong twist lock plug (**black** to hot & **white** to neutral). Change WC-1 or Cobramatic contactor to 115VAC (see Appendix for contactor information).
2. Plug the 115VAC plug from the unit into a standard wall outlet or cut off the plug and wire it to the three prong twist lock; **green** to pin with tang, **black** to hot and **white** to neutral pin.
3. Tape off WC-1 **red** and **green** leads and turn off Posa Start switch as Posa Start is not used.
4. If the power supply has a Remote/Standard contactor switch set it to "REMOTE".

	Two Prong	Three Prong
Miller	039-635	039-687
Hubbel	7101, 7224 & 3223 or 9768	4770 or 4773

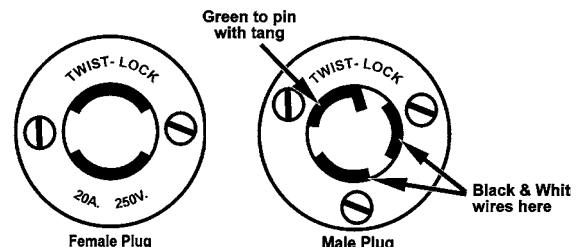

M-3

The WC-1 Weld Control or the Cobramatic Cabinet can also be connected to Miller CV power supplies with a 14-Pin amphenol as follows:

1. Connect the **black** and **white** contactor leads from the WC-1 or Cobramatic to pins A & B of the 14 pin amphenol; **black** to "A" and **white** to "B". Place the contactor in the CLOSING CONTACTS position (see Appendix for contactor information).
2. Plug the 115VAC plug from the unit into a standard wall outlet or cut off the plug and wire it to the 14-Pin amphenol; **black** to pin "I", **white** to pin "G" and **green** to pin "K".
3. Tape off WC-1 **red** and **green** leads and turn off Posa Start switch as Posa Start is not used.
4. If the power supply has a Remote/Standard contactor switch set it to "REMOTE".

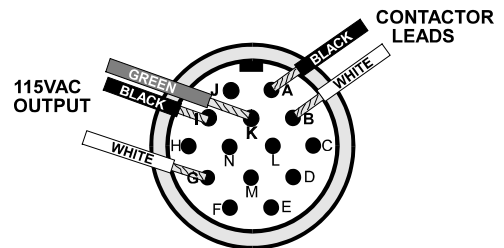

Note: Some Miller amphenols do not have pins A & B. If this is the case do the following for the contactor hook-up. Everything else is unchanged.

1. Connect the **black** contactor lead to pin "J" and cut off the **white** contactor lead (not used). Place the contactor in the 115VAC contactor position.

P/N 005-0658
Complete 25' cable with 14-Pin (S clocked) amphenol attached.

P/N 005-0316
Complete 8' cable with 14-Pin (S clocked) amphenol attached.

14-Pin Amphenol	MK P/N's	MILLER P/N's
Socket	153-0325	094-481
Cord Clamp	411-0035	108-852
Rubber Boot	301-0021	---

Miller Electric

M-4

The WC-1 Control Box or a Cobramatic system can also be connected to Miller CC power supplies with 14-Pin amphenols as follows:

1. Connect the **black** and **white** contactor leads from the WC-1 or Cobramatic to pins A & B of the 14-Pin amphenol; **black** to "**A**" and **white** to "**B**". Place the contactor in CLOSING CONTACTS position (see Appendix for contactor information).
2. Plug the 115VAC plug from the WC-1 or Cobramatic into a standard wall outlet.
3. *Connect the **red** and **green** leads from the WC-1 to the power supply positive (+) and negative (-) terminals of the power supply; **red** to **positive (+)** and **green** to **negative (-)**.
4. If the power supply has a Remote/Standard contactor switch set it to "REMOTE" (14-Pin).
5. Set the amperage control to "panel" and the process switch to "TIG".
6. Place polarity switch to DC Reverse Polarity (electrode positive).
7. The Posa Start must be used. See WC-1 or Cobramatic owner's manual for Posa Start information.

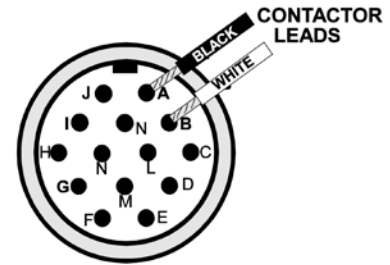

*See Appendix for Posa Start information.

14-Pin Amphenol	MK P/N's	MILLER P/N's
Socket	153-0325	094-481
Cord Clamp	411-0035	108-852
Rubber Boot	301-0021	---

CAUTION: MAKE SURE THAT THE HIGH FREQUENCY IS TURNED OFF OR DAMAGE TO THE WC-1 OR COBRAMATIC WILL OCCUR.

M-5

Older style MM35, MM200 and Spoolmate 200 units without 14-Pin amphenols have either 4-Pin plastic AMP plugs (trigger plug) and/or a 4-Pin Amphenol plug in the lower right hand corner.

Some newer Miller power supplies, such as the MM250-X & MM251 use this same receptacle (AMP style) for the trigger on their push type guns.

1. Connect the **black** and **white** contactor leads from the WC-1 or Cobramatic to pins **B** & **D** of the 4-Pin Amphenol; **black** to "**B**" and **white** to "**D**".

The AMP plug only has two pins installed so place the contactor leads on those two pins (color code not important). Place the contactor in CLOSING CONTACTS (see Appendix for contactor information).

2. There is no 115VAC available on these units so plug the WC-1 or Cobramatic into a wall outlet.
3. Tape off WC-1 **red** and **green** leads and turn off Posa Start switch as Posa Start is not used.

Note: The feeder inside these units will also be turned on when using the trigger plug, so disengage the spring tension on drive roll. The 4 pin amphenol plug does not turn on the feeder.

4-Pin Amphenol	Amphenol P/N's	Miller P/N's
Socket	3106A18-4P	073-329
Cord Clamp	3057-1010	073-331
Rubber Boot	MS3420-10 MS3420-8	---

4-Pin AMP	MK P/N's	AMP P/N's	Miller P/N's
Socket	153-0998	206429-1	079-878
Cord Clamp	153-0946	206062-3	048-834
Pins (2 req.)	153-0958	66099-2/-3	---

Miller Electric

M-6

The Vintage/Millermatic 250/Hobart Beta-Mig 2510 kit P/N 005-0205 includes everything needed to attach to these power supplies.

1. The blank panel on the front of the unit is removed and the Spool Gun Control is put in its place. Both the push gun and the spool gun may be hooked-up at the same time.
2. For spool gun operation set the desired voltage on the Millermatic 250 front panel and set the wire speed on the bottom of the spool gun.
3. For push gun operation set both voltage and wire speed on the Millermatic 250 front panel.

Kit P/N 005-0629, for both the MM250-X & MM251, is an adapter pigtail that goes between the Prince XL Spool-gun and the power supply. The control module inside the power supplies are used for WFS. The spool-gun power cable goes to the positive (+) terminal inside the wire feeder door on the welder.

M-7

The WC-1 Weld Control or the Cobramatic Cabinet can be connected to Miller CC power supplies without 14-Pin amphenols as follows: Miller has used two types of contactor plugs over the years. In the 1970's a male two prong "twist lock" plug was used. In the early 1980's they changed to a 5 pin amphenol plug. **All TIG machines use closing contacts!**

1. For power supplies with the two prong plug, connect the **black** and **white** contactor leads from the WC-1 or Cobramatic to the two prong plug. For power supplies with 5-Pin amphenols connect the **black** and **white** contactor leads to pins A & B of the 5-Pin amphenol; **black** to "**A**" and **white** to "**B**". Place unit in CLOSING CONTACTS (see Appendix for contactor information).
2. Plug the 115VAC plug from the WC-1 or Cobramatic into a standard wall outlet.
3. *Connect the **red** and **green** leads extending from the WC-1 to the power supply positive (+) and negative (-) terminals of the power supply; **red** to **positive (+)** and **green** to **negative (-)**.
4. If the power supply has a Remote/Standard contactor switch set it to "REMOTE".
5. Set the amperage control to "panel" and the process switch to "TIG".
6. Place polarity switch to DC Reverse Polarity (electrode positive).
7. The Posa Start must be used. See WC-1 or Cobramatic owner's manual for Posa Start information.

*See Appendix for Posa Start information.

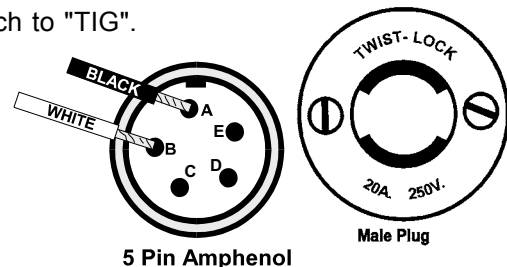

Two Prong Plug	
Miller P/N	039-618
Hubbel P/N	7102
5-Pin Amphenol	
Miller P/N	039-273
Cord Clamp	039-685

CAUTION: MAKE SURE THAT THE HIGH FREQUENCY IS TURNED OFF OR DAMAGE TO THE WC-1 OR COBRAMATIC WILL OCCUR.

M-8

The WC-1 Weld Control of the Cobramatic Cabinet can be connected to CC power supplies that do not have contactors (stick machines) as follows. With Both the WC-1 Weld Control or Cobramatic Cabinet **the Contactor box is recommended:**

1. Connect the WC-1 or Cobramatic to the contactor box as shown in the Appendix.
2. Connect the spool gun power lug to the contactor box "TORCH" side and the positive (+) lead from the power supply to the "+ WELD POWER" side.
3. Plug the 115VAC plug from the WC-1 or Cobramatic into a standard wall outlet.
4. *Connect the **red** and **green** leads from the WC-1 to the power supply positive (+) and negative (-) terminals of the power supply; **red** to **positive (+)** and **green** to **negative (-)**.
5. Place polarity switch to DC Reverse Polarity (electrode positive).
6. The Posa Start must be used. See WC-1 or Cobramatic owner's manual for Posa Start information.

Note: These instructions are for use with all manufacturers of CC stick machines.

Powcon

P-1

The WC-1 Weld Control or the Cobramatic Cabinet is connected to Powcon power supplies as follows:

1. Connect the **black** and **white** contactor leads extending from the WC-1 or Cobramatic to pins 8 & 9 of the 14-Pin AMP plug; **black** to **8** and **white** to **9**. Place the contactor in the CLOSING CONTACTS position (see Appendix for contactor information).
2. Plug the 115VAC plug extending from the WC-1 or Cobramatic into a standard wall outlet or cut off the plug and wire it to the 14 pin; **black** to pin **1**, **white** to pin **2** and **green** to pin **3**.
3. Add a **jumper** between pins **10** and **14**.
4. Tape off WC-1 **red** and **green** leads and turn off Posa Start switch as Posa Start is not used.

Note: Use in Mig or CV position.

14-Pin AMP	Powcon P/N's	AMP P/N's
Plug	250011-001	206044-1
Cord Clamp		206070-1
Pins (7 req.)	---	66099-2/-3

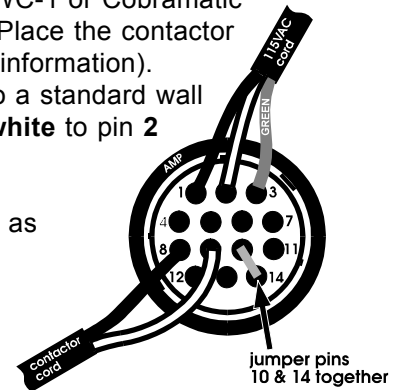

P-2

The PA-G1 Control (P/N 005-0264) is connected to Powcon power supplies as follows:

1. Connect the **red** and **green** contactor leads from the Control to pins 8 & 9 of the 14 pin AMP plug; **red** to **8** and **green** to pin **9**. Place the contactor in the CLOSING CONTACTS position (see Appendix for contactor information).
2. Connect the **black** wire from the Control to pin **4** and the **white** wire to pin **5**.
3. Add a **jumper** between pins **10** and **14**.

Note: Use in GMAW (CV) position.

14-Pin AMP	Powcon P/N's	AMP P/N's
Plug	250011-001	206044-1
Cord Clamp		206070-1
Pins (7 req.)	---	66099-2/-3

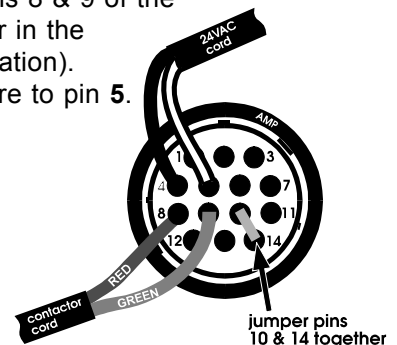

P-3

The PA-G1 Control (P/N 005-0264) is connected to Powcon power supplies as follows:

1. Connect the **red** and **green** contactor leads from the Control to pins B & E of the 17 pin amphenol plug; **red** to **B** and **green** to **E**. Place the contactor in the CLOSING CONTACTS position (see Appendix for contactor information).
2. Connect the **black** wire from the Control to pin **S** and the **white** wire to pin **J**.
3. Add a **jumper** between pins **P** and **T**.

Note: Use in GMAW (CV) position.

17-Pin Amphenol	Powcon P/N's	Amphenol P/N's
Plug & Pins	930014-101	3106A20-29PW
Cord Clamp	930014-301	3057-1012
Boot	930014-405	MS3420-12

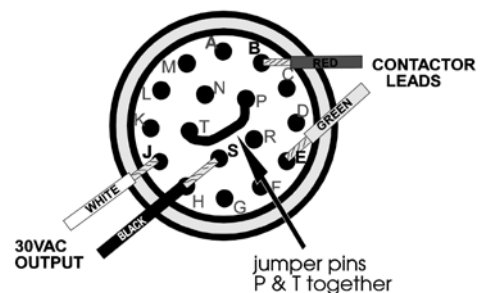

Note: Newer Powcon units use a 14-Pin similar to Miller. See section M-3 or use the 14-Pin Control - P/N 005-0261.

Powcon

P-4

The WC-1 Weld Control or the Cobramatic Cabinet is connected to Powcon power supplies as follows:

1. Connect the **black** and **white** contactor leads extending from the WC-1 or Cobramatic to pins 8 & 9 of the 14-Pin AMP plug; **black** to **8** and **white** to **9**. Place the contactor in the CLOSING CONTACTS position (see Appendix for contactor information).
2. Plug the 115VAC plug extending from the WC-1 or Cobramatic into a standard wall outlet.
3. Add a **jumper** between pins **10** and **14**.
4. *Connect the **red** and **green** leads extending from the WC-1 to the power supply positive (+) and negative (-) terminals of the power supply; **red** to **positive (+)** and **green** to **negative (-)**.
5. Place the Weld Process Switch to "SMAW" (stick) position.
6. The Posa Start must be used; see WC-1 or Cobramatic owner's manual for Posa Start operation.

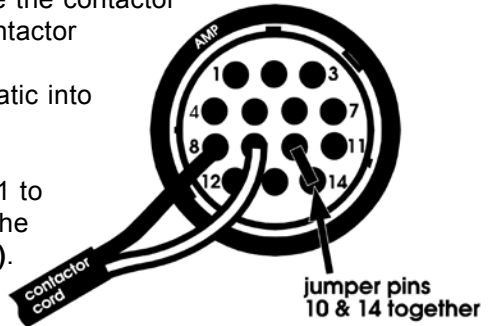

*See Appendix for Posa Start information.

14-Pin AMP	Powcon P/N's	AMP P/N's
Plug	250011-001	206044-1
Cord Clamp		206070-1
Pins (7 req.)	---	66099-2/-3

P-5

The WC-1 Weld Control or the Cobramatic Cabinet is connected to Powcon power supplies as follows:

1. Connect the **black** and **white** contactor leads from the WC-1 or the Cobramatic to pins B & E of the 17-Pin amphenol plug; **black** to **B** and **white** to **E**. Place the contactor in the CLOSING CONTACTS position (see Appendix for contactor information).
2. Plug the 115VAC plug from the WC-1 or the Cobramatic into a standard wall outlet.
3. *Connect the **red** and **green** leads extending from the WC-1 to the power supply positive (+) and negative (-) terminals of the power supply; **red** to **positive (+)** and **green** to **negative (-)**.
4. **Jumper** pins **T** and **P** together.
5. Place the Weld Process Switch to "SMAW" (stick) position.
6. The Posa Start must be used; see WC-1/Cobramatic owner's manual for Posa Start operation.

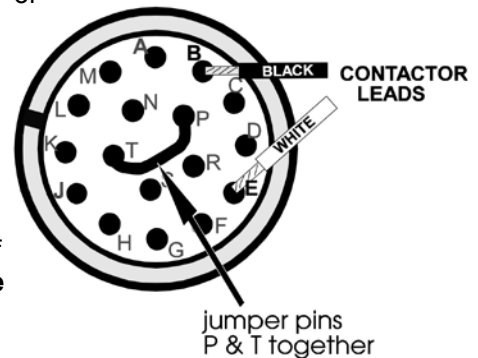

*See below for Cobramatic Posa Start information.

17-Pin Amphenol	Powcon P/N's	Amphenol P/N's
Plug & Pins	930014-101	3106A20-29PW
Cord Clamp	930014-301	3057-1012
Boot	930014-405	MS3420-12

Note: Newer Powcon units use a 14-Pin similar to Miller. Use section M-3 or use 14-Pin Control - P/N 005-0261

The Gunslinger 260 kit (P/N 005-0617) plugs directly into the amphenol on the front of the unit. The lug on the power cable of the Prince XL Spool-gun will be hooked up to the positive (+) terminal of the welder. It is inside the door housing the unit's wire feeder, just under the feeder.

A Cobramatic Cabinet may be hooked up to the Gunslinger 260 as follows:

1. Plug the 115VAC plug extending from the Cobramatic Cabinet into a standard wall outlet.
2. Connect the **black** and **white** contactor leads of the Cobramatic Cabinet to pins **1** and of the Spool-gun plug on the front of the Gunslinger 260. Place the contactor on the Cobramatic in the CLOSING CONTACTS position (see Appendix for contactor information).
3. Even though you're operating a Cobramatic push-pull system instead of a spool-gun, the Gunslinger 260 must have the Mode Plug inserted into the Spool-gun location. The power cable to the Cobramatic would be hooked up to positive (+) terminal which is just under the units wire feeder inside the door.

4-Pin AMP	MK P/N's	AMP P/N's
Socket	153-0998	206429-1
Cord Clamp	153-0946	206062-3
Pins (2 req.)	153-0958	66099-2/-3

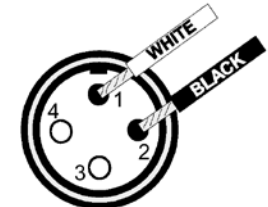

Back side of plug

Thermal Dynamics (Includes ThermalArc)

T-1

The WC-1 or Cobramatic can be connected to the Thermal Viking 210/250-GM power supplies as follows:

1. Connect the **black** and **white** contactor leads from the WC-1 or Cobramatic to the spade style terminal inside the door above the wire feed motor of the Viking unit. The contactor leads will replace the existing wires going to the two spades on the right side. Place the contactor in CLOSING CONTACTS position (see Appendix for contactor information).
2. Plug the 115VAC plug from the WC-1 or Cobramatic cabinet into a standard wall outlet.
3. Tape off the WC-1 **red** and **green** leads and turn off the Posa Start switch as the Posa Start will not be used.

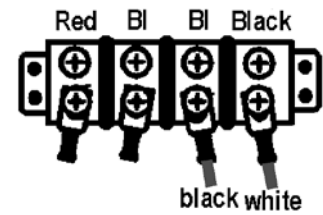

A Prince XL Spool-gun may be connected to the Viking 210/250-GM power supplies without the use of a control module by using a MK **003-1623** Panel mount kit with 4 female (.25) Forked Tongue connectors. (See the NOTE below - No WFS at the Prince XL Torch).

1. Punch 1" hole in the front panel approximately 2" below meter cut-off hole.
2. Cut off the **blue**, **green** and **white** (or yellow if there's no white wire) wires from the back side of the 003-1623 panel mount. Crimp the female spade connectors to the **brown**, **orange**, **black** and **red** wires.
3. Mount the 003-1623 amphenol in the 1" hole. Inside the hinged left door there's a terminal strip with four male spades. Remove the existing wires and fasten the wires from the amphenol as shown below:

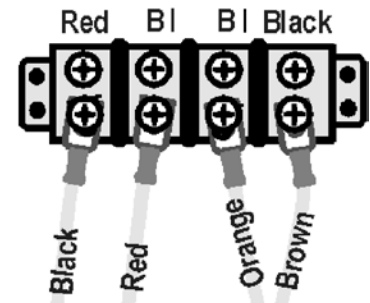

NOTE: With this hook-up, the WFS (Wire Feed Speed) Potentiometer on the Prince® Spool gun is unoperative. WFS will be controlled by the control on the front of the welder.

T-2

A Prince XL Spool-gun may be hooked up to the Thermal-Arc 300GMS, Fabricator 210 or 300-LF Welder with a MK 005-0261 Miller style 14-Pin PA-M1 Control (See section M-1). Note - Cut off the lug on the Spool-gun power cable and install a male Dinse style connector (MK P/N 153-0755). Exception - Fabricator 210 that has a specification with an "A" at the end (See Note 11).

A Cobramatic system may be hooked up to this same power supply. The instructions in section M-3 would apply. A Dinse style (MK P/N 153-0755) connector would be needed on the power cable from the welder to the Cobramatic Cabinet.

Note: A prince XL Spool Gun can be connected to the Fabricator 250 using a WC-1 only.

T-3

A Prince XL Spool gun may be hooked up to many of the Thermal-Arc engine driven welders. The Exciter and Hog units are CC only and need a WC-1 Control Box that is CC Posa-start Ready and connected with a contactor box as shown in the Appendix. The Predator and the Explorer units are CC/ CV and normally come without a contactor. Then a WC-1 and a Contactor box is needed.

Appendix

PosaStart Connections	27
Contactora Output Configuration	28
MK200 Contactora Box Connections	29
WC-1 & Spool Gun Connections	30
Spool Gun Controls	31
Utility Style Welders	32
Cobramatic Connectivity	33
Prince XL Spool Gun Connectivity	34

This page intentionally blank.

POSASTART CONNECTIONS

The Cobramatic and Cobra II Wire Feeders each have, a single black 14 ga. wire with an alligator clip, extending from the back connected to the main board. This is the voltage sensing lead for the PosaStart circuit. In order for PosaStart to properly work, this lead must be connected to the welding GROUND.

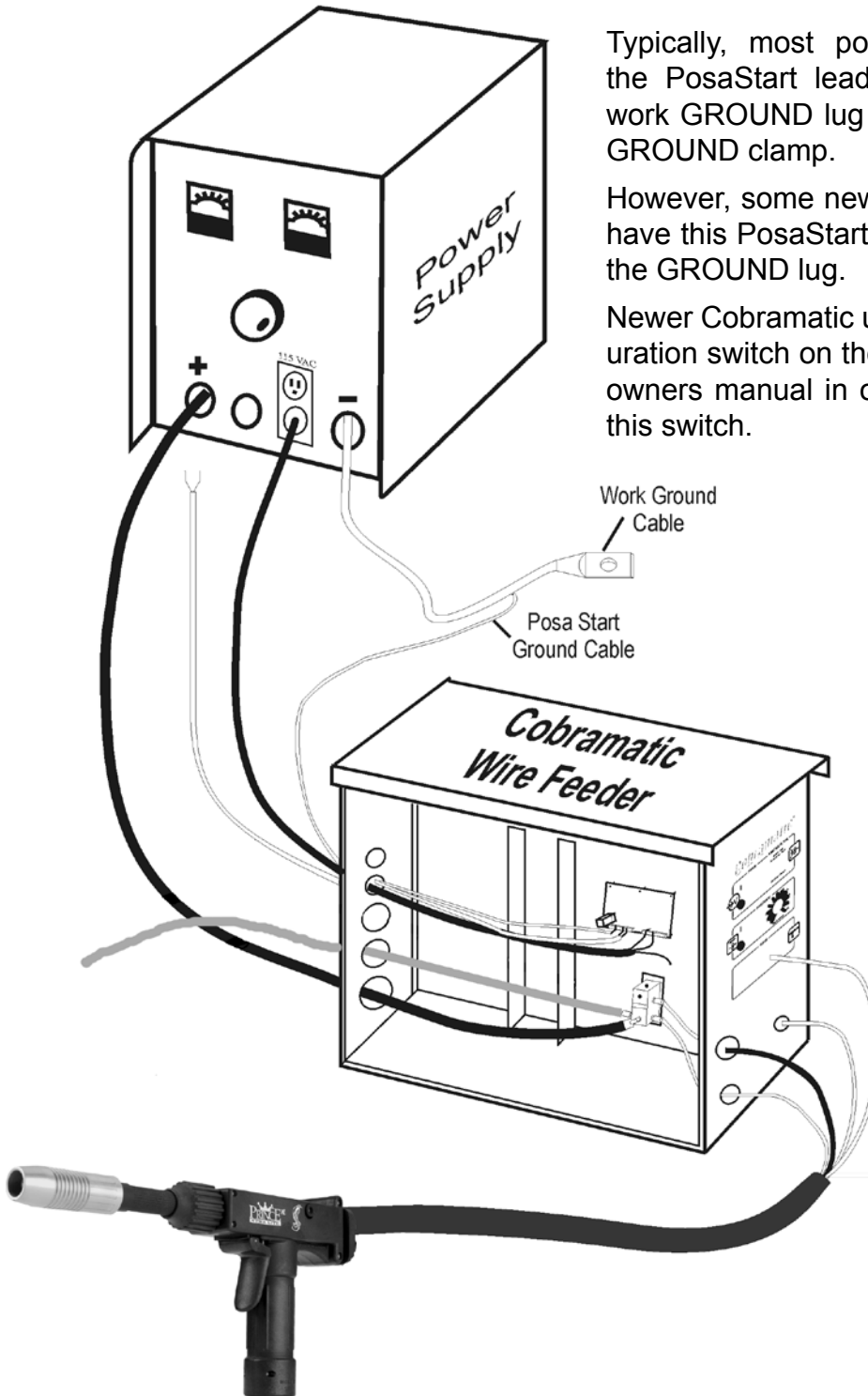

Typically, most power supplies will accept the PosaStart lead connected to either the work GROUND lug on their front panel or the GROUND clamp.

However, some newer types of inverters must have this PosaStart lead connected directly to the GROUND lug.

Newer Cobramatic units have a CC/CV configuration switch on the main board. Consult the owners manual in order to properly configure this switch.

PosaStart Configuration Switch on Cobramatic Main Board
SW1

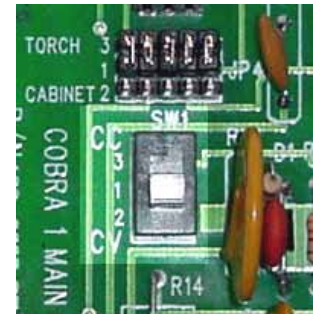

CONTACTOR OUTPUT CONFIGURATION

Contactor Selection

There are two types of contactor signals that various power supply manufacturers use. A "Closing Contact or Contactor" and a "115VAC Contactor" signal. Once the power supply contactor is closed, the welding leads become electrically live and are referred to as being "live" or "hot".

For the Closing Contactor type, the weld control simply touches the two contactor leads together (providing a continuity signal to the power supply) like a light switch. ALL Cobramatic wire feeders and Weld Controls are shipped in this configuration (Figure A). Since no voltage is applied to the leads in this configuration, it is safe to handle and there is no risk of personal injury from electrocution.

COBRAMATIC / WC-1 MAIN BOARD

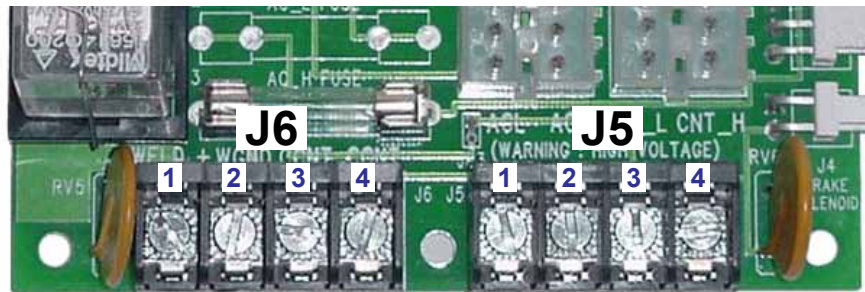

**CLOSING
CONTACTS
CONNECTION**

WHITE
BLACK

Figure A

For the 115VAC Contactor type, the weld control must send 115VAC into the power supply to close the contactor. In order to obtain this configuration from a Cobramatic wire feeder or Weld Control, the internal wiring or each must be modified as shown (Figure B).

COBRAMATIC / WC-1 MAIN BOARD

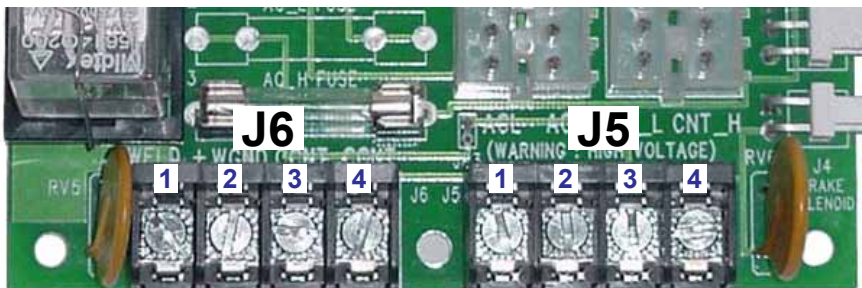

BLACK
WHITE

**115 VAC
CONTACTOR
CONNECTION**

Figure B

If a 115VAC signal is required, remove the four screws from both sides of control box, and remove cover. For Cobramatic open left door. Locate **white** and **black** wire on #3 and #4 of terminal strip J6. Move **white** wire to #3 and **black** wire to #4 of terminal strip J5. The unit will now supply 115VAC on the black (hot) and white (neutral) wires.

WARNING: Disconnect the WC-1 & Cobramatic from all power sources before changing contactor.

MK200 CONTACTOR BOX CONNECTIONS

1. Remove the existing black and white contactor cord from WC-1 or Cobramatic.
2. Connect the leads extending from the contactor box to the WC-1/ Cobramatic main board as shown below.

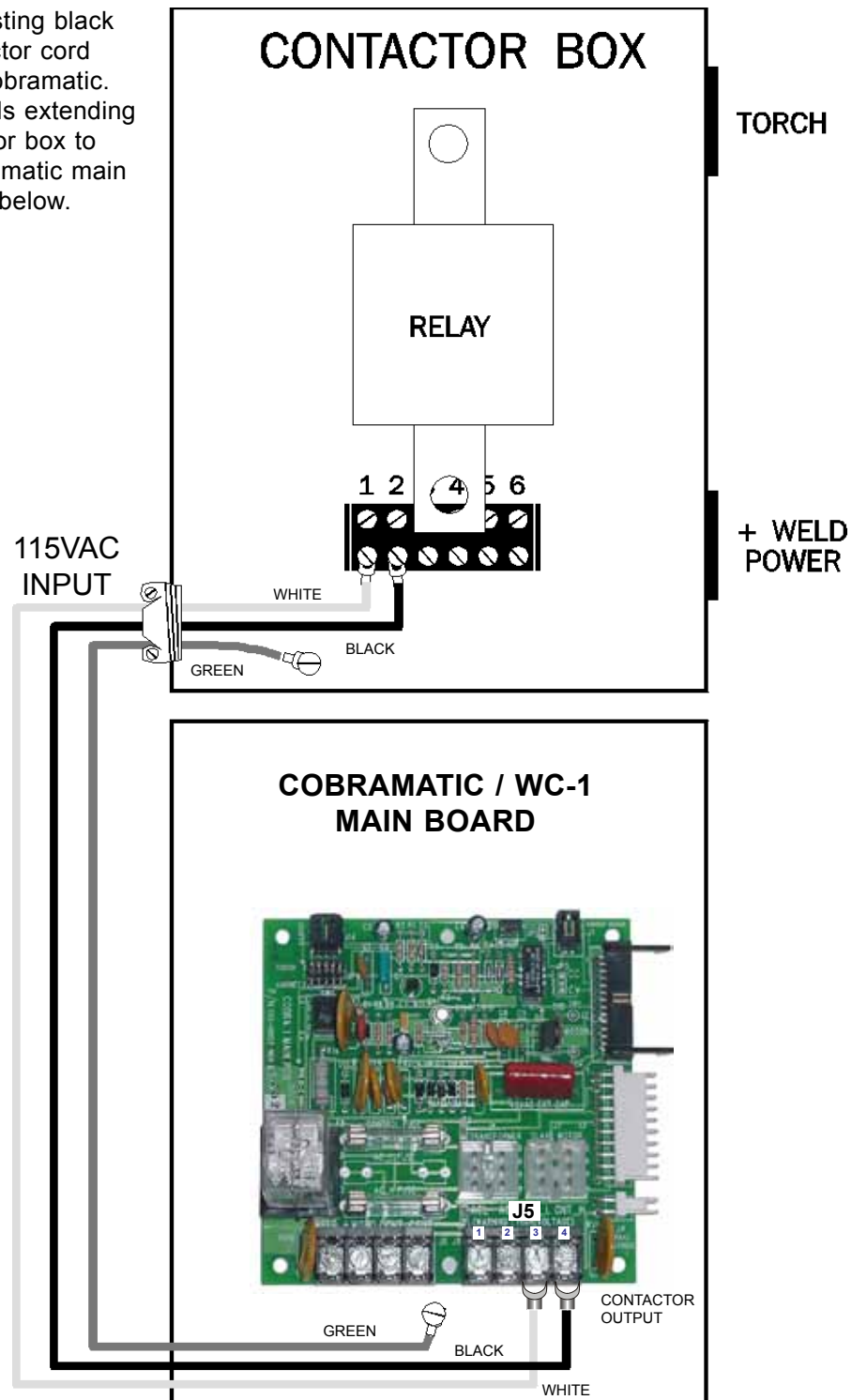

CAUTION: When working with voltages present in this Product and others, always observe warning and caution signs. Service must only be performed by qualified service personnel.

WC-1 & SPOOLGUN HOOK-UP

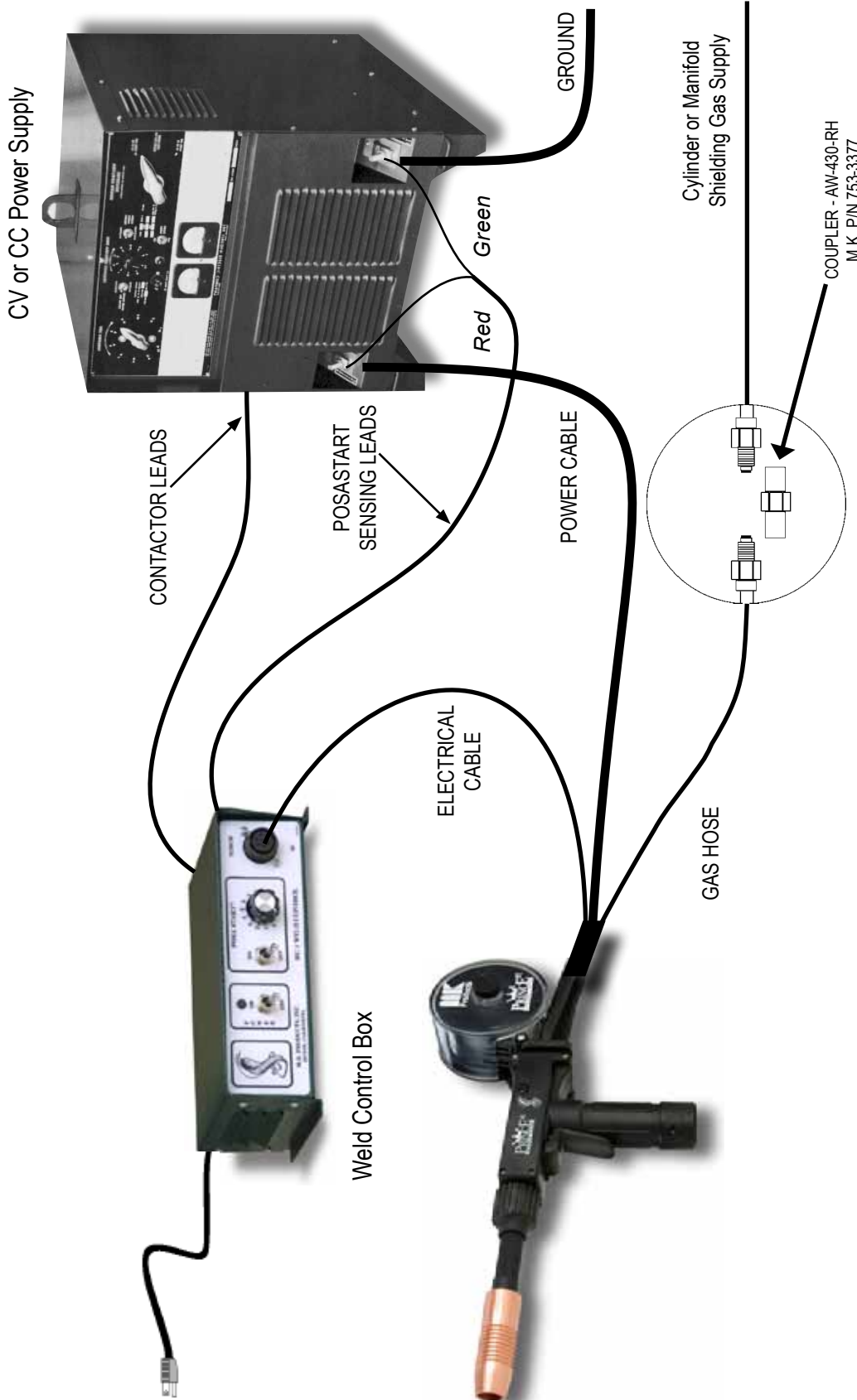

NOTE: The Posa Start feature permits the WC-1 to be used in combination with any Constant Current DC power source with an open circuit voltage in excess of 55 volts.

SPOOL GUN CONTROLS

FOR POWER SUPPLIES THAT SUPPLY AN AUXILIARY 26 VAC



PA-G1
P/N 005-0264

The PA-G1 is designed to hook-up to CV power supplies that supply an auxiliary 26 VAC @ 1.7 amps and uses a closing contact signal. The unit is supplied with bare wires that must be connected to the power supply. Some examples of power supplies that can be hooked-up are:

Lincoln SP-250, 255 & Wirematic 250 & 255
Beta-Mig 200 & Beta-Mig LF
Airco Dip-Pak 200, 225 & 250

FOR POWER SUPPLIES WITH 14 PIN AMPHENOLS



PA-M1
P/N 005-0261

The PA-M1 connects directly to Miller power supplies (24V system) that are classified with 14-Pin amphenols as type 6 or 9 and to Thermal Arc units, such as:

Miller Welders

Millermatic 200
Shopmaster
XMT's & Maxtron

Deltawelds
CO Series, Regency's
Trailblazer 250, 251, 280, All engine-driven welders with a CV-tap and a 14 pin amphenol.

Thermal-Arc Welders

Thermal-Arc 300GMS CC/CV, 400GMS
Fabricator 210, 250, 300 LF



PA-L1
P/N 005-0676

The PA-L1 connects directly to Lincoln Electric power supplies (42V system) with 14-Pin (X-clocked) amphenol connectors, such as:

Lincoln Electric

Ranger 9, 10, 250, 275, 304 CV Series
Commander 300, 500 (See Note 10) Vantage 500
Invertec V300-Pro, V350-Pro (Fac. or Adv.)



Panasonic Gunslinger 260
P/N 005-0617



ESAB (L-TEC) MIGMASTER 250
P/N 005-0206



MillerMatic250X/251
P/N 005-0629



Fabricator Series
P/N 005-0689



MILLER VINTAGE, MILLERMATIC 250, HOBART BETAMIG 2510 or IronMan 250

P/N 005-0205

This easy to install, plug in module fits the Millermatic 250, Miller Vintage machine, or Hobart Betamig 2510. It and a Prince Spool Gun are all that is needed to get your customer up and running.

UTILITY STYLE WELDERS

There are many other welders made by companies like CK Systematics, Century Manufacturing, and some foreign manufactured machines that are capable of welding aluminum, utilizing the Cobramatic system or Prince XL Spool Guns. These units can usually be broken down into two categories.

1. A utility MIG welder with the wire feeder built into the unit. These units need to be in 200 to 275 amp range and operate from 208/230/460 Volts
2. A CC/CV Power supply capable of accepting a wire feeder. (These units are usually 3-Phase).

Units in the second category usually have some sort of connector for the wire feeder that needs to be identified by model and pin configuration. Then an adapter pigtail may be made that will interconnect with these units.

Units in the first category are a little more difficult. There's usually no internal or external hookup for a secondary wire feed system; 115VAC must be derived from a secondary source (i.e. extension cord from a wall outlet) to run the Cobramatic system or a Prince XL Spool Gun with a WC-1 Control Box. What becomes difficult is "How to trigger the contactor?"

If the trigger leads from the units are accessible, then the contactor leads from the Cobra Cabinet or the WC-1 Control Box may be spliced to these leads (Cobra or WC-1 must be in "Closing Contacts" mode). However, this will also trigger the units internal welder, so care must be taken to loosen the idler roll on the unit's internal wire feeder so that it does not feed wire while welding with the Cobramatic Cabinet or Spool Gun.

Sometimes the most difficult thing to locate is the source of welding current. There has to be a cable going to the unit's internal wire feeder. A connection can usually be made to one of the ends of this cable to the Spool Gun.

A Cobramatic Cabinet or a WC-1 Control for the Prince XL Spool Gun may be hooked up to many other MIG welders beside those listed on the previous pages. In some cases, the size and output of many of the smaller units, especially those that operate on 115VAC only, do not lend themselves to an efficient arc. Examples of these are the Lincoln SP125, the Millermatic 130XP, and the Hobart Handler. These units only deliver 18-19 Open Circuit Volts (max). Since welding on 1/8" thick aluminum requires 100 to 120 amps at 20 to 21 volts, the welds are marginal at best.

COBRAMATIC CONNECTIVITY

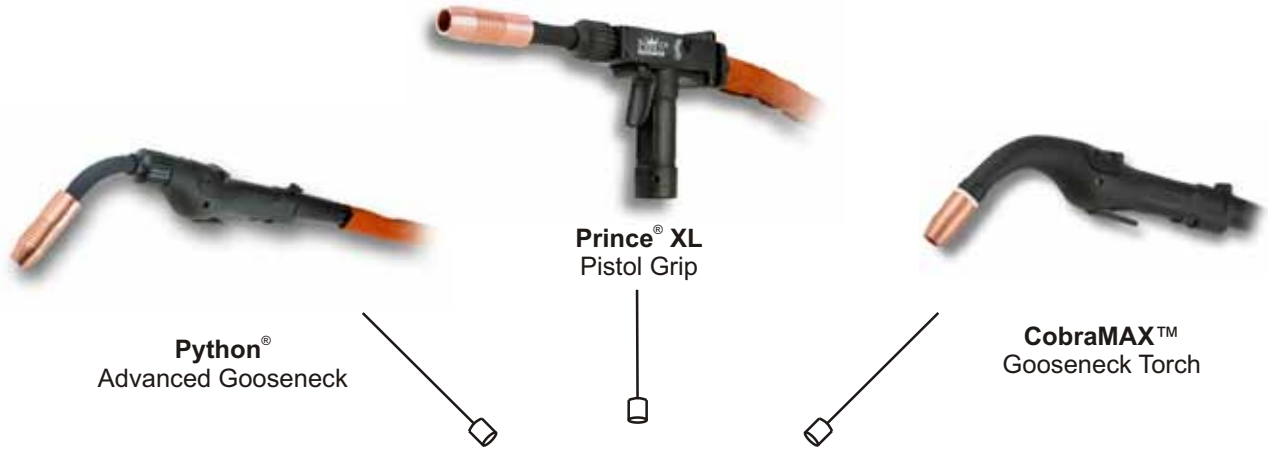

V350PRO
120VAC Output
14 Pin



XMT 304
120VAC Output
14 Pin



Ultra Flex™ 350
120VAC Output
19 & 14 Pin



SVI 450i
120VAC Output
19 Pin

PRINCE XL SPOOL GUN CONNECTIVITY

PowerMIG 300



Direct Connect

MillerMatic 251



Interface Cable
005-0629



Fabricator 250



Interface Cable
005-0689



MultiMaster 260



Interface Cable
005-0206



Gunslinger 260



Interface Cable
005-0617



PA-L1
005-0676



PA-M-1
005-0261



PA-M-1
005-0261



Interface Cable
005-0206



V350PRO



XMT 304



Ultra Flex™ 350



Migmaster 250

			
WARNING	<ul style="list-style-type: none"> ● Do not touch electrically live parts or electrode with skin or wet clothing. ● Insulate yourself from work and ground. 	<ul style="list-style-type: none"> ● Keep flammable materials away. 	<ul style="list-style-type: none"> ● Wear eye, ear and body protection.
Spanish AVISO DE PRECAUCION	<ul style="list-style-type: none"> ● No toque las partes o los electrodos bajo carga con la piel o ropa mojada. ● Aíslese del trabajo y de la tierra. 	<ul style="list-style-type: none"> ● Mantenga el material combustible fuera del área de trabajo. 	<ul style="list-style-type: none"> ● Protéjase los ojos, los oídos y el cuerpo.
French ATTENTION	<ul style="list-style-type: none"> ● Ne laissez ni la peau ni des vêtements mouillés entrer en contact avec des pièces sous tension. ● Isolez-vous du travail et de la terre. 	<ul style="list-style-type: none"> ● Gardez à l'écart de tout matériel inflammable. 	<ul style="list-style-type: none"> ● Protégez vos yeux, vos oreilles et votre corps.
German WARNUNG	<ul style="list-style-type: none"> ● Berühren Sie keine stromführenden Teile oder Elektroden mit Ihrem Körper oder feuchter Kleidung! ● Isolieren Sie sich von den Elektroden und dem Erdboden! 	<ul style="list-style-type: none"> ● Entfernen Sie brennbares Material! 	<ul style="list-style-type: none"> ● Tragen Sie Augen-, Ohren- und Körperschutz!
Portuguese ATENÇÃO	<ul style="list-style-type: none"> ● Não toque partes elétricas e electrodos com a pele ou roupa molhada. ● Isole-se da peça e terra. 	<ul style="list-style-type: none"> ● Mantenha inflamáveis bem guardados. 	<ul style="list-style-type: none"> ● Use proteção para a vista, ouvido e corpo.
Japanese 注意事項	<ul style="list-style-type: none"> ● 通電中の電気部品、又は溶材にヒフやぬれた布で触れないこと。 ● 施工物やアースから身体が絶縁されている様にして下さい。 	<ul style="list-style-type: none"> ● 燃えやすいものの側での溶接作業は絶対にしてはなりません。 	<ul style="list-style-type: none"> ● 目、耳及び身体に保護具をして下さい。
Chinese 警告	<ul style="list-style-type: none"> ● 皮肤或湿衣物切勿接觸帶電部件及綽條。 ● 使你自已與地面和工件絕緣。 	<ul style="list-style-type: none"> ● 把一切易燃物品移離工作場所。 	<ul style="list-style-type: none"> ● 佩戴眼、耳及身體勞動保護用具。
Korean 위험	<ul style="list-style-type: none"> ● 전도체나 용접봉을 젖은 헝겍 또는 피부로 절대 접촉치 마십시오. ● 모재와 접지를 접촉치 마십시오. 	<ul style="list-style-type: none"> ● 인화성 물질을 접근 시키지 마시오. 	<ul style="list-style-type: none"> ● 눈, 귀와 몸에 보호장구를 착용하십시오.
Arabic تحذير	<ul style="list-style-type: none"> ● لا تلمس الاجزاء التي يسري فيها التيار الكهربائي أو الأقطاب بجلد الجسم أو بالملايين المبللة بالماء. ● ضع عازلا على جسمك خلال العمل. 	<ul style="list-style-type: none"> ● ضع المواد القابلة للاشتعال في مكان بعيد. 	<ul style="list-style-type: none"> ● ضع أدوات وملابس واقية على عينيك وأذنيك وجسمك.

READ AND UNDERSTAND THE MANUFACTURER'S INSTRUCTION FOR THIS EQUIPMENT AND THE CONSUMABLES TO BE USED AND FOLLOW YOUR EMPLOYER'S SAFETY PRACTICES.

SE RECOMIENDA LEER Y ENTENDER LAS INSTRUCCIONES DEL FABRICANTE PARA EL USO DE ESTE EQUIPO Y LOS CONSUMIBLES QUE VA A UTILIZAR, SIGA LAS MEDIDAS DE SEGURIDAD DE SU SUPERVISOR.

LISEZ ET COMPRENEZ LES INSTRUCTIONS DU FABRICANT EN CE QUI REGARDE CET EQUIPMENT ET LES PRODUITS A ETRE EMPLOYES ET SUIVEZ LES PROCEDURES DE SECURITE DE VOTRE EMPLOYEUR.

LESEN SIE UND BEFOLGEN SIE DIE BETRIEBSANLEITUNG DER ANLAGE UND DEN ELEKTRODENEINSATZ DES HERSTELLERS. DIE UNFALLVERHÜTUNGSVORSCHRIFTEN DES ARBEITGEBERS SIND EBENFALLS ZU BEACHTEN.

			
<ul style="list-style-type: none"> ● Keep your head out of fumes. ● Use ventilation or exhaust to remove fumes from breathing zone. 	<ul style="list-style-type: none"> ● Turn power off before servicing. 	<ul style="list-style-type: none"> ● Do not operate with panel open or guards off. 	WARNING
<ul style="list-style-type: none"> ● Los humos fuera de la zona de respiración. ● Mantenga la cabeza fuera de los humos. Utilice ventilación o aspiración para gases. 	<ul style="list-style-type: none"> ● Desconectar el cable de alimentación de poder de la máquina antes de iniciar cualquier servicio. 	<ul style="list-style-type: none"> ● No operar con panel abierto o guardas quitadas. 	Spanish AVISO DE PRECAUCION
<ul style="list-style-type: none"> ● Gardez la tête à l'écart des fumées. ● Utilisez un ventilateur ou un aspirateur pour ôter les fumées des zones de travail. 	<ul style="list-style-type: none"> ● Débranchez le courant avant l'entretien. 	<ul style="list-style-type: none"> ● N'opérez pas avec les panneaux ouverts ou avec les dispositifs de protection enlevés. 	French ATTENTION
<ul style="list-style-type: none"> ● Vermeiden Sie das Einatmen von Schweißrauch! ● Sorgen Sie für gute Be- und Entlüftung des Arbeitsplatzes! 	<ul style="list-style-type: none"> ● Strom vor Wartungsarbeiten abschalten! (Netzstrom völlig öffnen; Maschine anhalten!) 	<ul style="list-style-type: none"> ● Anlage nie ohne Schutzgehäuse oder Innenschutzverkleidung in Betrieb setzen! 	German WARNUNG
<ul style="list-style-type: none"> ● Mantenha seu rosto da fumaça. ● Use ventilação e exaustão para remover fumo da zona respiratória. 	<ul style="list-style-type: none"> ● Não opere com as tampas removidas. ● Desligue a corrente antes de fazer serviço. ● Não toque as partes elétricas nuas. 	<ul style="list-style-type: none"> ● Mantenha-se afastado das partes moventes. ● Não opere com os painéis abertos ou guardas removidas. 	Portuguese ATENÇÃO
<ul style="list-style-type: none"> ● ヒュームから顔を離すようにして下さい。 ● 換気や排煙に十分留意して下さい。 	<ul style="list-style-type: none"> ● メンテナンス・サービスに取りかかる際には、まず電源スイッチを必ず切して下さい。 	<ul style="list-style-type: none"> ● パネルやカバーを取り外したまま機械操作をしないで下さい。 	Japanese 注意事項
<ul style="list-style-type: none"> ● 頭部遠離煙霧。 ● 在呼吸區使用通風或排風器除煙。 	<ul style="list-style-type: none"> ● 維修前切斷電源。 	<ul style="list-style-type: none"> ● 儀表板打開或沒有安全罩時不準作業。 	Chinese 警告
<ul style="list-style-type: none"> ● 얼굴로부터 용접가스를 멀리하십시오. ● 호흡지역으로부터 용접가스를 제거하기 위해 가스제거기나 통풍기를 사용하십시오. 	<ul style="list-style-type: none"> ● 보수전에 전원을 차단하십시오. 	<ul style="list-style-type: none"> ● 판넬이 열린 상태로 작동치 마십시오. 	Korean 위험
<ul style="list-style-type: none"> ● ابعد رأسك بعيداً عن الدخان. ● استعمل التهوية أو جهاز ضغط الدخان للخارج لكي تبعد الدخان عن المنطقة التي تتنفس فيها. 	<ul style="list-style-type: none"> ● اقطع التيار الكهربائي قبل القيام بأية صيانة. 	<ul style="list-style-type: none"> ● لا تشغيل هذا الجهاز اذا كانت الاغطية الحديدية الواقية ليست عليه. 	Arabic تحذير

LEIA E COMPREENDA AS INSTRUÇÕES DO FABRICANTE PARA ESTE EQUIPAMENTO E AS PARTES DE USO, E SIGA AS PRÁTICAS DE SEGURANÇA DO EMPREGADOR.

使う機械や溶材のメーカーの指示書をよく読み、まず理解して下さい。そして貴社の安全規定に従って下さい。

請詳細閱讀並理解製造廠提供的說明以及應該使用的銀焊材料，並請遵守貴方的有關勞動保護規定。

이 제품에 동봉된 작업지침서를 숙지하시고 귀사의 작업자 안전수칙을 준수하시기 바랍니다.

اقرأ بتمعن وافهم تعليمات المصنع المنتج لهذه المعدات والمواد قبل استعمالها واتبع تعليمات الوقاية لصاحب العمل.

3 YEAR LIMITED WARRANTY

Effective February 1, 2003

This warranty supersedes all previous MK Products warranties and is exclusive, with no other guarantees or warranties expressed or implied.

LIMITED WARRANTY - MK Products, Inc., Irvine, California warrants that all new and unused equipment furnished by MK Products is free from defects in workmanship and material as of the time and place of delivery by MK Products. No warranty is made by MK Products with respect to trade accessories or other items manufactured by others. Such trade accessories and other items are sold subject to the warranties of their respective manufacturers, if any.

MK Products' warranty does not apply to components having normal useful life of less than one (1) year, such as relay points, wire conduit, tungsten, and welding torch parts that come in contact with the welding wire, including gas cups, gas cup insulators, and contact tips where failure does not result from defect in workmanship or material.

MK Products shall, exclusively remedy the limited warranty or any duties with respect to the quality of goods, based upon the following options:

- (1) repair
- (2) replacement
- (3) where authorized in writing by MK Products, the reasonable cost of repair or replacement at our Irvine, California plant; or
- (4) payment of or credit for the purchase price (less reasonable depreciation based upon actual use) upon return of the goods at customer's risk and expense. Upon receipt of notice of apparent defect or failure, MK Products shall instruct the claimant on the warranty claim procedures to be followed.

As a matter of general policy only, MK Products may honor an original user's warranty claims on warranted equipment in the event of failure resulting from a defect within the following periods from the date of delivery of equipment to the original user:

- 1. Torches, Weldheads & Water Recirculators..... 1 year**
- 2. All Other Equipment..... 3 years**
- 3. Repairs90 days**

Classification of any item into the foregoing categories shall be at the sole discretion of MK Products. Notification of any failure must be made in writing within 30 days of such failure.

A copy of the invoice showing the date of sale must accompany products returned for warranty repair or replacement.

All equipment returned to MK Products for service must be properly packaged to guard against damage from shipping. MK Products will not be responsible for any damages resulting from shipping.

Normal surface transportation charges (both ways) for products returned for warranty repair or replacement will be borne by MK Products, except for products sold to foreign markets.

ANY EXPRESS WARRANTY NOT PROVIDED HEREIN AND ANY IMPLIED WARRANTY, GUARANTY, OR REPRESENTATION AS TO PERFORMANCE, AND ANY REMEDY FOR BREACH OF CONTRACT WHICH, BUT FOR THIS PROVISION, MIGHT ARISE BY IMPLICATION, OPERATION OF LAW, CUSTOM OF TRADE, OR COURSE OF DEALING, INCLUDING ANY IMPLIED WARRANTY OF MERCHANTABILITY OR OF FITNESS FOR PARTICULAR PURPOSE, WITH RESPECT TO ANY AND ALL EQUIPMENT FURNISHED BY MK PRODUCTS, IS EXCLUDED AND DISCLAIMED BY MK PRODUCTS.

EXCEPT AS EXPRESSLY PROVIDED BY MK PRODUCTS IN WRITING, MK PRODUCTS ARE INTENDED FOR ULTIMATE PURCHASE BY COMMERCIAL/INDUSTRIAL USERS AND FOR OPERATION BY PERSONS TRAINED AND EXPERIENCED IN THE USE AND MAINTENANCE OF WELDING EQUIPMENT AND NOT FOR CONSUMERS OR CONSUMER USE. MK PRODUCTS WARRANTIES DO NOT EXTEND TO, AND NO RE-SELLER IS AUTHORIZED TO EXTEND MK PRODUCTS' WARRANTIES TO ANY CONSUMER.

USE OF OTHER THAN *GENUINE* MK PRODUCTS' CONSUMABLES, PARTS, AND ACCESSORIES MAY INVALIDATE YOUR PRODUCT WARRANTY.



16882 Armstrong Ave.
Irvine, CA 92606
Tel (949)863-1234
Fax (949)474-1428
www.mkproducts.com

DATE: February 1, 2003



www.mkproducts.com
16882 Armstrong Ave.
Irvine, California 92606
TEL (949) 863-1234 FAX (949) 474-1428